



POWER TOOLS 2026



THE EINHELL PROFESSIONAL PHILOSOPHY.

**Quality you can see. Performance you can feel.
Designed for everyone who needs to deliver on a daily
basis.**

Anyone working professionally needs tools they can rely on at all times. The Einhell Professional range stands for uncompromising performance, high-quality workmanship and a clear focus on the needs of commercial users. It is specifically designed for professional tradespeople, gardeners and landscapers, as well as demanding power users who use their tools intensively on a daily basis under heavy-duty conditions.

Target audience: Commercial users with professional requirements

Here, uncompromising quality meets sophisticated design and maximum performance.

Performance

More powerful and compact brushless motors for optimised power transmission enable faster progress and consistent performance.

Quality of materials

The use of robust housing materials, reinforced components and durable gearboxes ensures significantly improved resistance to wear, dirt, moisture and mechanical stress.

Functionality

Additional features such as ergonomic soft grips, intelligent controls and advanced safety functions enhance efficiency, precision and user comfort in day-to-day professional use.

Ergonomics & Design

A distinctive, high-quality product design conveys professionalism at first glance. Improved ergonomics, optimised grip areas, balanced weight distribution and high-quality finishes inspire confidence and enhance the quality of day-to-day work.

COMPACT



COMPACT SERIES



MORE COMPACT

- up to 30 % smaller*
- up to 40 % lighter*



MORE POWER

- up to 52 % higher performance*



MORE FEATURES

- e.g. Anti-kickback

* In comparison to non-compact tools

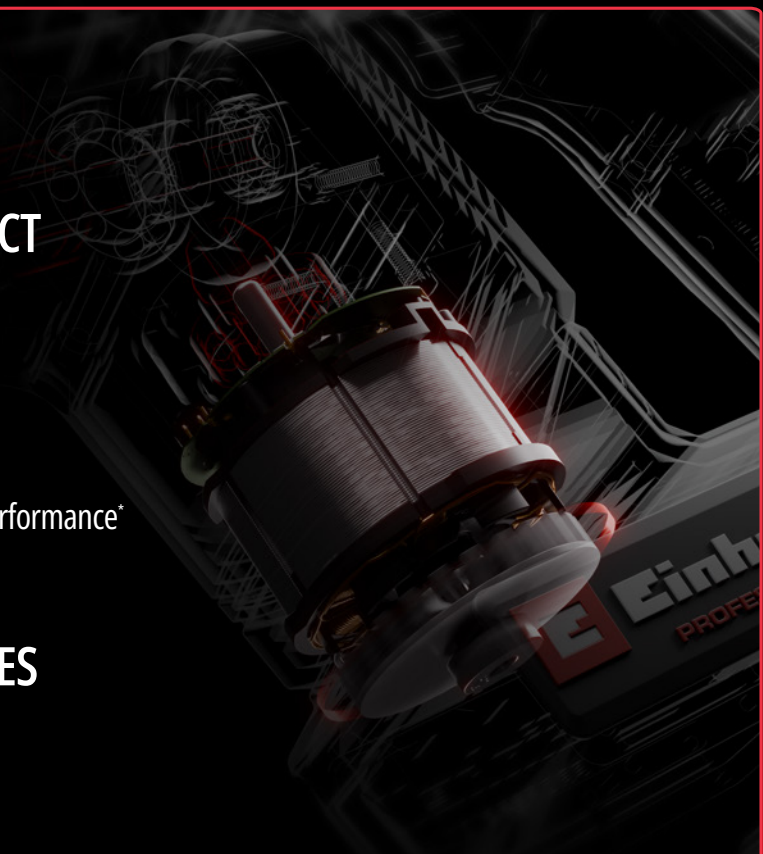

POWER X-CHANGE

Power X-Change Battery System	8
Batteries	11
Twin-Packs	12
Starter Kits	13
Chargers	13

PROFESSIONAL POWER X-CHANGE COMPACT CORDLESS POWER TOOLS

Professional Cordless Drills with Impact Function	16
Professional Cordless Drills	18
Professional Cordless Impact Drivers	20
Professional Cordless Hammer Drill	24
Professional Cordless Rotary Hammer	25
Professional Cordless Cut-Off Grinder	26
Professional Cordless Circular Saw	27

PROFESSIONAL POWER X-CHANGE CORDLESS POWER TOOLS

Professional Cordless Drills with Impact Function	29
Professional Cordless Drills	37
Professional Cordless Drywall Screwdrivers	41
Professional Cordless Rivet Gun	43
Professional Cordless Impact Drivers	44
Professional Cordless Rotary Hammers	47
Professional Cordless Rotary Hammers D-Handle	51
Professional Cordless Demolition Hammer	53
Professional Cordless Paint/Mortar Mixer	54
Professional Cordless Grease Gun	55
Professional Cordless Angle Grinders	56
Professional Cordless Wall Liner	66
Professional Cordless Routers	67
Professional Cordless Palm Router	70
Professional Cordless Planer	71
Professional Cordless Jigsaws	72
Professional Cordless Circular Saws	74
Professional Cordless Plunge Cut Saw	76
Professional Cordless All Purpose Saws	77
Professional Cordless Multifunctional Tools	79
Professional Cordless Drywall Polishers	81
Professional Cordless Brush Sander	83
Professional Cordless Band Sander	84
Professional Cordless Rotating Sander	85
Professional Cordless Eccentric Polisher	86
Professional Cordless Nailer	87
Professional Cordless Stapler	88
Professional Cordless Lights	89
Professional Cordless Wet and Dry Vacuum Cleaners	91
Professional Cordless Compressors	94

PROFESSIONAL CORDED TOOLS

Professional Demolition Hammer	99
Professional Paint/Mortar Mixer	100
Professional Router	101
Professional Angle Grinders	102
Professional Table Saw	104



Do you have any questions?
The Einhell Service hotline
will be happy to help you.

Einhell Service

Eschenstr. 6
94405 Landau/Isar
Germany

Tel. +49 9951 959 2000

Service-DE@einhell.com
www.einhell-service.de

Einhell Germany AG

Wiesenweg 22
94405 Landau/Isar
Germany

info@einhell.de
www.einhell.de



Einhell

CORDLESS EXCELLENCE.



***TWO PARTNERS. ONE MISSION.
MAXIMUM PERFORMANCE.***

Einhell

OFFICIAL
TOOL EXPERT



**AMG
PETRONAS
FORMULA 1 TEAM**

MORE POWER FOR PROS.

MORE

PERFORMANCE.*
ENDURANCE.*
WARRANTY.**
LIFETIME.*
FUNCTIONALITY.

* Approximate values compared to standard carbon brush motors
** For Brushless Motors upon online registration

WITH BRUSHLESS MOTOR

25% MORE Performance*
50% MORE Endurance*
100% MORE Lifetime*
»» 10 year Motor warranty**

* Approximate values in comparison to conventional carbon brush motors.
** Upon online registration.

ENHANCED MOTOR PERFORMANCE AND MORE BATTERY POWER

The PROFESSIONAL tool range and brushless technology form the Dream Team for: More power. More reliability. More endurance.

Combined, they ensure that these powerful cordless tools exceed even the highest expectations.

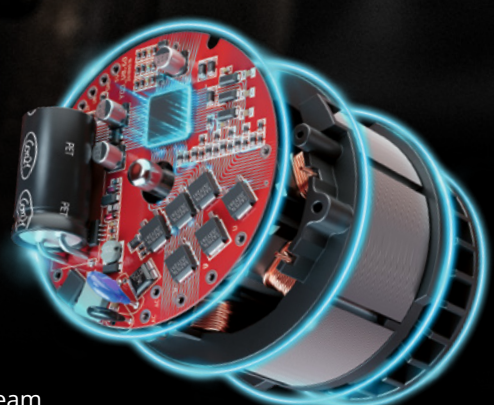

THE EINHELL GUARANTEE PROMISE.

In addition to offering excellent value for money, we also ensure that our products are reliable, high-quality and safe.

This is reflected in our various warranties: take advantage of our warranty extension on Einhell tools and Power X-Change batteries to benefit from our top warranty service for even longer.

- » **3-Year Einhell Product Warranty**
Warranty extension for your Power X-Change device to 3 years.
- » **30 Day Money Back Guarantee**
For 100% satisfaction with your Power X-Change device.
- » **Power X-Change Battery Warranty**
Warranty extension for Power X-Change batteries to 3 years.



* This warranty covers only defects in the engine that are due to a material or manufacturing defect!

THIS IS HOW

Find out more at einhell.de, **register** in your customer account and **apply** for the warranty. Further information is available at www.einhell.de/en/services/warranties/

PROFESSIONAL WARRANTIES

- » **PROFESSIONAL Warranty**
3-year warranty, even for commercial use. Confident of the durability of our PROFESSIONAL tools and garden equipment, we offer an extended 3-year warranty, even for commercial use.
- » **Brushless Warranty**
10-year warranty on Einhell brushless motors. We are committed to the reliable quality of our tools and the safety of our products. When you register your new Einhell brushless product, the warranty on your Einhell brushless motor is extended to a total of 10 years.



THIS IS HOW

Find out more at einhell.de, **register** in your customer account and **apply** for the warranty. Further information is available at www.einhell.de/en/services/warranties/

ONE BATTERY FOR OVER 350 TOOLS, ELIMINATING SYSTEM CHAOS.

POWER X-CHANGE is the only truly standardised battery platform for home, garden and workshop use. While other manufacturers use diverse battery systems, Einhell consistently relies on a **single, universal platform for all purposes**. The **PXC BATTERY** fits in any device, regardless of whether you are using a drill, lawn mower, wet and dry vacuum cleaner or high-pressure cleaner. **This eliminates system chaos, the need for different chargers and compatibility issues.**

Other brands offer separate battery platforms for each of their performance ranges. This leads to confusion and additional expense, because different batteries are needed for different devices. With **POWER X-CHANGE**, you won't have this problem! A single system covers the entire range of tools, from garden equipment and household tools to recreational products.



FLEXIBILITY AND PERFORMANCE ACCORDING TO YOUR NEEDS.

Each situation poses unique challenges in terms of performance. With **POWER X-CHANGE**, you are free to select the precise battery capacity that suits your project's needs. Thanks to battery options ranging from **2.0 Ah to 8.0 Ah**, you are free to choose whether you prefer lightweight tools with low energy needs or high-performance machines with maximum runtime.

For particularly demanding tasks, **two 18 V batteries can be combined to produce 36 V**.

Runtime is automatically doubled on certain tools

Selected tools intelligently run on two 18 V batteries, one after the other:

- One PXC battery runs while the other waits its turn.
- The tool automatically switches over to the second battery when needed.

This results in double the runtime, with no need for interruptions or manual action.

When combined with tools that use two batteries at once for 36 V, you can have up to four batteries in place, offering 2x 36 V and automatically switching over. Perfect for prolonged use and steady performance.





THE BATTERY PLATFORM THAT GROWS WITH YOU.

A single investment in the **POWER X-CHANGE** system offers long-term flexibility. From a cordless screwdriver today to hedge trimmers tomorrow, your PXC battery grows as your projects develop. The platform is designed for expansion, so that you can add new tools at any time without having to worry about battery compatibility.

Featuring over 350 tools, **POWER X-CHANGE** is one of the largest battery platforms on the market. The product range is constantly growing, ensuring not only that you have the right tool for your current project but also that you are well equipped for the challenges to come. **Einhell is focused on the future: once you join the system, you will benefit from new opportunities for years to come.**

COST-EFFICIENT AND PRACTICAL.

POWER X-CHANGE saves not only money but also space. Why buy a separate battery for every device when a single battery type is enough for all applications? This reduces purchase costs and eliminates the need for extra chargers.

The sophisticated battery technology ensures that PXC batteries have a particularly long service life. Fewer batteries mean less electronic waste. And you, as the user, save money at the same time.

INNOVATIVE BATTERY TECHNOLOGIES.

For use under the toughest conditions, **SEALED Technology** (rated IP57) protects the PXC battery from water and dust.

With up to 1350 watts of power per PXC battery, PXC tools offer top-rate cordless performance. Thanks to **Twin Pack Technology**, two 18 V batteries can be combined to produce 36 V, providing up to 2700 watts of power.

Multi-Ah Technology allows you to choose between maximum runtime (+60 %) and a service life that is 3x longer by simply pushing a button.

The Active Battery Management System (ABS) reliably protects the battery from overload, deep discharge and overheating through constant cell monitoring and smart load management. At the same time, ABS optimizes each cell for maximum runtime, extended service life and safe performance. In sleep mode, the system saves energy, keeping the battery ready for use.

With **POWER X-CHANGE Plus**, batteries offer not only more capacity, but also more power, exactly when and where it is needed.



POWER X-CHANGE PLUS

By switching to the new "21700" cell format (21 mm diameter, 70.0 mm length) our latest Power X-Change batteries have acquired the best combination of power/running time and weight.

Why? Using this cell technology it is possible to achieve the same power and running time with five cells instead of the previous ten.

Benefits? The new batteries are 13% more compact and 12% lighter than their predecessors – at 100% power and running time.

Results: Light-weight all-rounders for energy-intensive applications such as in cordless chainsaws.

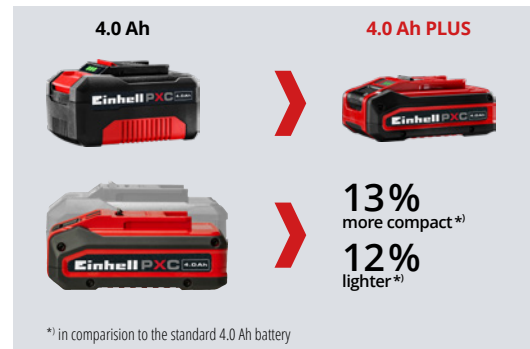

MULTI-AH

Thanks to MULTI-Ah Technology, switching over from a 5 Ah battery to a 8 Ah battery is really easy and can be done with just the push of a button. The 5 Ah battery has a 3x longer total service life and is suitable for lighter applications (e.g. cordless lamp or cordless screwdriver). The 8 Ah battery offers them maximum running time for more capacity-intensive applications (e.g. cordless lawn mower or cordless wet and dry vacuum cleaners).

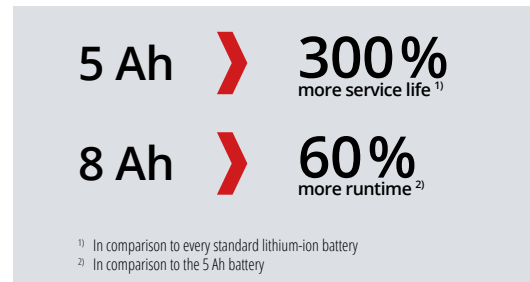

TWIN-PACK

Every Power X-Change battery from Einhell has a voltage of 18 V. If more power is required for more powerful tools, **two 18 V batteries are simply combined in one 36 V device** thanks to Twin-Pack Technology. Doubling the voltage automatically doubles the power.

Double Twin-Pack Technology allows you to work even longer without recharging. This uses four batteries. If the first two batteries are empty, the system automatically switches to the two additional batteries.



COMPACT

Einhell's compact tools impress with their powerful performance and sleek new design. Ideal for easy, powerful and fatigue-free work in the workshop and around the home.

MORE COMPACT

- up to **30%** shorter*
- up to **40%** slimer*
- up to **60%** lighter*

MEHR POWER

- up to **52%** higher performance*

MEHR FEATURES

- e.g. **Anti-kickback**



* In comparison to non-compact tools

SEALED



NO CHANCE FOR DUST AND WATER.

Officially tested according to IP57 protection class.*

WHAT DOES IP57 MEAN?

DUST 5

Protected from all types of foreign bodies and dust – be it wood, brick or metal.



7 WATER

Protected from high pressure water spray and temporary submersion – to a maximum depth of 1 m for up to 30 minutes.

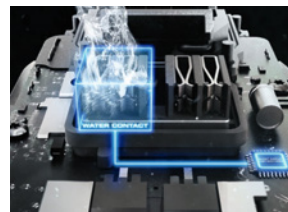

In addition to the sealed housing there is a sensor controlled safety cut out to prevent short circuiting under water.

After the contacts have been dried, the battery is ready for use again.

* Protection according to IP57 applies to the battery itself. It does not apply to tools operated with the battery.

SEALED TECHNOLOGY

Our most advanced battery system SEALED

- >>> First IP57 rechargeable battery worldwide
- >>> High Power 4 Ah Battery Pack
- >>> Water proof
- >>> Dust proof



**DUST
PROOF**

**WATER
PROOF**

Accessories – Batteries

4.0 Ah SEALED Power X-Change Plus Battery



Items supplied	1 battery
PXC battery voltage / capacity	18 V / 4.0 Ah
Battery power	max. 900 W
Product weight	0.61 kg
Article number	4511627
EAN	4 006825 673227

3.0 Ah SEALED Power X-Change Plus Battery











Items supplied	1 battery
PXC battery voltage / capacity	18 V / 3.0 Ah
Battery power	max. 900 W
Product weight	0.60 kg
Article number	4511618
EAN	4 006825 672794

ACCESSORIES – BATTERIES











One battery for all devices

Our rechargeable batteries are not only available individually (solo item), but also in a Twin Pack. To get started in the Einhell world, we recommend choosing a Starter Kit (battery + charger)

◀◀ Less weight and size PXC Batteries More power and runtime ▶▶

					
	2.0 Ah	2.5 Ah	3.0 Ah PLUS	3.0 Ah SEALED	4.0 Ah
Article number (1 battery)	4511395	Only available in Starter Kits	4511501	4511618	4511396
EAN		-			
Power	max. 450 W	max. 720 W	max. 900 W	max. 900 W	max. 900 W
Weight	400 g	460 g	585 g	595 g	670 g
Features					
PLUS - Extra Power			✓	✓	
SEALED				✓	
Multi-Ah					

◀◀ Less weight and size PXC Batteries More power and runtime ▶▶











					
	4.0 Ah PLUS	4.0 Ah SEALED	5.2 Ah	4-6 Multi-Ah	5-8 Multi-Ah
Article number (1 battery)	4511553	4511627	4511437	4511502	4511600
EAN					
Power	max. 900 W	max. 900 W	max. 1260 W	max. 1350 W	max. 1350 W
Weight	595 g	605 g	890 g	1020 g	1050 g
Features					
PLUS - Extra Power	✓	✓		✓	✓
SEALED		✓			
Multi-Ah				✓	✓

				
	3.0 Ah PLUS	4.0 Ah	4.0 Ah PLUS	5.2 Ah
Article number Twin-Pack (2 batteries)	4511631	4511489	4511629	4511526
EAN				

ACCESSORIES – STARTER KITS









Getting started is easy – with the Einhell Power X-Change Starter Kit

Technical data and features at a glance:

					
	2.5 Ah	4.0 Ah	4.0 Ah PLUS	5.2 Ah	4-6 Multi-Ah
Article number (1 battery + 1 charger)	4512097	4512042	4512159	4512147	4512143
EAN					
Article number (2 batteries + 1 Twincharger)	-	4512112	-	-	-
EAN	-		-	-	-
Charger (More information in the charger table)	3 A Charger	3 A Charger / 3 A Twincharger	3 A Charger	3 A Charger	6 A Boostcharger
Ready to go	50 min	75 min	75 min	100 min	60 min

ACCESSORIES – CHARGERS

One charger for all batteries – 100 % compatibility

					
	3 A Charger	3 A Carcharger	4 A Fastcharger	6 A Boostcharger	8 A Boostcharger
Article number (1 charger)	Only available in Starter Kits	4512113	4512103	Only available in Starter Kits	4512155
EAN	-			-	
Charging current	3 A	3 A	4 A	6 A	8 A
Number of ports for PXC batteries	1	1	1	1	1

			
	3 A Twincharger	4 A Twincharger	4 A Quattrocharger
Article number (1 charger)	4512069	4512161	4512102
EAN			
Charging current	3 A (per Port)	4 A (per Port)	4 A (per Port) (parallel charging of 2x2 batteries)
Number of ports for PXC batteries	2	2	4



- > Endless extendable
- > Tongue and groove connection
- > Snap-in function for secure fastening

PXC ACCESSORIES

Battery Mounting Gadget

Items supplied	2 battery mounting gadgets, 4 screws, 4 dowels	
Suitable for (batteries)	all 18 V Power X-Change batteries	
Special feature	The batteries latch in place and are secure in every position	
Article number	4514155	 4 006825 658774



- > Protects the battery against dust and moisture

PXC ACCESSORIES

Battery Protector

Items supplied	1 battery cover	
Suitable for (batteries)	all 18 V Power X-Change batteries	
Can be used for (devices)	HYPRESSO 18/24-1, TE-DA 18/760 Li, GE-WS 18/10 Li	
Property	Protects the battery against dust and moisture	
Article number	4140151	 4 006825 670844

BATTERY CHARGING TIME TABLE

	2.0 Ah	2.5 Ah	3.0 Ah	4.0 Ah	5.2 Ah	6.0 Ah	8.0 Ah	
Power X-Charger 3 A								
Power X-Twincharger 3 A (parallel charging of 2 batteries)	40 min	50 min	60 min	75 min	100 min	120 min	160 min	
Power X-Car Charger 3 A								
Power X-Fastcharger 4 A								
Power X-Twincharger 4 A (parallel charging of 2 batteries)	30 min	37 min	45 min	60 min	80 min	90 min	120 min	
2x2 Power X-Quattrocharger 4 A (parallel charging of 2 batteries)								
Power X-Boostcharger 6 A *	30 min	27 min	32 min	40 min	50 min	60 min	80 min	
Power X-Boostcharger 8 A **	30 min	27 min	32 min	40 min	40 min	45 min	60 min	

* Only 2.5 Ah - 8.0 Ah batteries can be charged with 6 A. Batteries of lower capacity are charged with a lower current.

** Only 5.2 Ah - 8.0 Ah batteries can be charged with 8 A. Batteries of lower capacity are charged with a lower current.

POWER X CHANGE

PROFESSIONAL COMPACT CORDLESS POWER TOOLS



Operating times

The product descriptions specify the operating times that the devices can achieve when using the various batteries.

2.0 Ah	2.5 Ah	3.0 Ah	4.0 Ah	5.2 Ah	6.0 Ah	8.0 Ah
160 pcs	200 pcs	240 pcs	320 pcs	420 pcs	480 pcs	640 pcs

For optimum performance of the devices, we recommend the batteries with operating times highlighted in dark grey

Einhell Accessories

Accessories from the Einhell Accessories range are marked with

A

PROFESSIONAL CORDLESS DRILL WITH IMPACT FUNCTION
TP-CD 18/70-C Li-i Brushless

NEW



PXC battery voltage	18 V
Idle speed	0 - 450 / 0 - 2000 min ⁻¹
Blow rate	0 - 6750 / 0 - 30000 min ⁻¹
Torque (hard)	70 Nm
Torque settings	21+1+1
Drill chuck	13 mm
Housing length	157 mm
Product weight	1.1 kg (excl. battery)
Number of batteries / chargers included in the scope of delivery	0 pcs / 0 pcs
Packaging	Colour box
Article number	4514340



1x 18 V

Screwing 6 x 60 mm screws into soft wood – max. quantity per battery charge

2.0 Ah 330 pcs	2.5 Ah 415 pcs	3.0 Ah 495 pcs	4.0 Ah 660 pcs	5.2 Ah 860 pcs	6.0 Ah 990 pcs	8.0 Ah 1320 pcs
--------------------------	--------------------------	--------------------------	--------------------------	--------------------------	--------------------------	---------------------------

**BRUSHLESS
COMPACT**

- 2-speed transmission**
70 Nm
21 torque settings
- Compact design**
lightweight and handy
- 3 functions**
□ screwing
○ drilling
△ impact drilling
- 13 mm chuck**
quick-release system
metal construction
- Anti-kickback**
protection against injury
in the event of kickback
- LED light**
optimum illumination



PROFESSIONAL CORDLESS DRILL WITH IMPACT FUNCTION TP-CD 18/50-C Li-i Brushless

NEW

PXC battery voltage	18 V
Battery charging time 18 V / 3.0 Ah	45 min (4 A charger)
Idle speed	0 - 500 / 0 - 2000 min ⁻¹
Blow rate	0 - 7500 / 0 - 30000 min ⁻¹
Torque (hard)	50 Nm
Torque settings	20+1+1
Drill chuck	13 mm
Housing length	152 mm
Product weight	1.0 kg (excl. battery)
Number of batteries / chargers included in the scope of delivery	2 pcs (18 V 3.0 Ah Sealed Li-Ion) / 1 pcs (4 A Charger)
Packaging	E-Case
Article number	4514406 



1x 18 V

Screwing 6 x 60 mm screws into soft wood – max. quantity per battery charge

2.0 Ah 330 pcs	2.5 Ah 415 pcs	3.0 Ah 495 pcs	4.0 Ah 660 pcs	5.2 Ah 860 pcs	6.0 Ah 990 pcs	8.0 Ah 1320 pcs
--------------------------	--------------------------	--------------------------	--------------------------	--------------------------	--------------------------	---------------------------

PROFESSIONAL CORDLESS DRILL WITH IMPACT FUNCTION TP-CD 18/50-C Li-i Brushless

**BRUSHLESS
COMPACT**

Same as previous item, but without battery(ies) / charger(s)

Number of batteries / chargers included in the scope of delivery	0 pcs / 0 pcs
Packaging	Colour box
Article number	4514400 



PROFESSIONAL CORDLESS DRILL TP-CD 18/70-C Li Brushless

NEW

PXC battery voltage	18 V
Idle speed	0 - 450 / 0 - 2000 min ⁻¹
Torque (hard)	70 Nm
Torque settings	21+1
Drill chuck	13 mm
Housing length	144 mm
Product weight	1.0 kg (excl. battery)
Number of batteries / chargers included in the scope of delivery	0 pcs / 0 pcs
Packaging	Colour box
Article number	4514335



1x 18 V

Screwing 6 x 60 mm screws into soft wood – max. quantity per battery charge

2.0 Ah	2.5 Ah	3.0 Ah	4.0 Ah	5.2 Ah	6.0 Ah	8.0 Ah
330 pcs	415 pcs	495 pcs	660 pcs	860 pcs	990 pcs	1320 pcs

**BRUSHLESS
COMPACT**



PROFESSIONAL CORDLESS DRILL TP-CD 18/50-C Li Brushless

NEW

PXC battery voltage	18 V
Idle speed	0 - 500 / 0 - 2000 min ⁻¹
Torque (hard)	50 Nm
Torque settings	20+1
Drill chuck	13 mm
Housing length	140 mm
Product weight	0.9 kg (excl. battery)
Number of batteries / chargers included in the scope of delivery	0 pcs / 0 pcs
Packaging	Colour box
Article number	4514405 

1x 18 V

Screwing 6 x 60 mm screws into soft wood – max. quantity per battery charge

2.0 Ah	2.5 Ah	3.0 Ah	4.0 Ah	5.2 Ah	6.0 Ah	8.0 Ah
330 pcs	415 pcs	495 pcs	660 pcs	860 pcs	990 pcs	1320 pcs



**BRUSHLESS
COMPACT**



PROFESSIONAL CORDLESS IMPACT DRIVER TP-CW 18/750-C Li Brushless

PXC battery voltage	18 V
Idle speed (step 1 / 2 / 3)	0 - 1000 / 0 - 1500 / 0 - 2200 min ⁻¹
Torque (stage 1 / 2 / 3 / Auto-Stop)	300 / 370 / 750 / 100 Nm
Loosening torque (max.)	1000 Nm
Number of torque settings	3 + 1
Tool mounting	External square (1/2")
Housing length	170 mm
Product weight	1.8 kg (excl. battery)
Number of batteries / chargers included in the scope of delivery	0 pcs / 0 pcs
Accessories	Bit adapter, 3-piece nut set
Packaging	Colour box
Article number	4510065



1x 18 V

Max. number of wheel bolts (hexagon head, wrench size 22 mm, tightened to 120 Nm) that can be released per battery charge

2.0 Ah	2.5 Ah	3.0 Ah	4.0 Ah	5.2 Ah	6.0 Ah	8.0 Ah
810 pcs	1010 pcs	1215 pcs	1620 pcs	2100 pcs	2430 pcs	3240 pcs

Accessories incl.



BRUSHLESS COMPACT



PROFESSIONAL CORDLESS IMPACT DRIVER TP-CW 18/350-C Li Brushless

PXC battery voltage	18 V
Idle speed (step 1 / 2 / 3)	0 - 1100 / 0 - 1700 / 0 - 2400 min ⁻¹
Torque (stage 1 / 2 / 3 / Auto-Stop)	140 / 200 / 350 / 100 Nm
Loosening torque (max.)	600 Nm
Number of torque settings	3 + 1
Tool mounting	External square (1/2")
Housing length	132 mm
Product weight	1.0 kg (excl. battery)
Number of batteries / chargers included in the scope of delivery	0 pcs / 0 pcs
Accessories	Bit adapter, 3-piece nut set
Packaging	Colour box
Article number	4510055



1x 18 V

Max. number of wheel bolts (hexagon head, wrench size 22 mm, tightened to 120 Nm) that can be released per battery charge

2.0 Ah	2.5 Ah	3.0 Ah	4.0 Ah	5.2 Ah	6.0 Ah	8.0 Ah
720 pcs	900 pcs	1080 pcs	1440 pcs	1870 pcs	2160 pcs	2880 pcs



Accessories incl.



BRUSHLESS COMPACT

- Drive**
1/2" external square
- Brushless motor**
durable and powerful
- Compact design**
132 mm housing length
- Power adjustment**
3 torque settings
Electronic speed control
- Power**
350 Nm torque
600 Nm release torque



PROFESSIONAL CORDLESS IMPACT DRIVER TP-CW 18/260-C Li Brushless

PXC battery voltage	18 V
Idle speed (step 1 / 2 / 3)	0 - 1000 / 0 - 1900 / 0 - 2700 min ⁻¹
Torque (stage 1 / 2 / 3 / Auto-Stop)	100 / 160 / 260 / 100 Nm
Loosening torque (max.)	500 Nm
Number of torque settings	3 + 1
Tool mounting	External square (1/2")
Housing length	119 mm
Product weight	0.95 kg (excl. battery)
Number of batteries / chargers included in the scope of delivery	0 pcs / 0 pcs
Accessories	Bit adapter, 3-piece nut set
Packaging	Colour box
Article number	4510090



1x 18 V

Max. number of wheel bolts (hexagon head, wrench size 22 mm, tightened to 120 Nm) that can be released per battery charge

2.0 Ah	2.5 Ah	3.0 Ah	4.0 Ah	5.2 Ah	6.0 Ah	8.0 Ah
635 pcs	795 pcs	950 pcs	1270 pcs	1650 pcs	1905 pcs	2540 pcs

Accessories incl.



**BRUSHLESS
COMPACT**



PROFESSIONAL CORDLESS IMPACT DRIVER TP-CI 18/250-C Li Brushless

PXC battery voltage	18 V
Idle speed	0 - 1300 / 0 - 2000 / 0 - 2800 min ⁻¹
Torque (stage 1 / 2 / 3)	90 / 150 / 250 Nm
Number of torque settings	3
Tool mounting	Internal hexagon 6.35 mm (1/4")
Housing length	113 mm
Product weight	0.95 kg (excl. battery)
Number of batteries / chargers included in the scope of delivery	0 pcs / 0 pcs
Packaging	Colour box
Article number	4510095 

1x 18 V

Screwing 6 x 60 mm screws into soft wood – max. quantity per battery charge

2.0 Ah	2.5 Ah	3.0 Ah	4.0 Ah	5.2 Ah	6.0 Ah	8.0 Ah
265 pcs	330 pcs	390 pcs	530 pcs	680 pcs	780 pcs	1060 pcs



**BRUSHLESS
COMPACT**



**PROFESSIONAL
CORDLESS HAMMER DRILL
TP-ID 18-C Li Brushless**

NEW

PXC battery voltage	18 V
Idle speed / blow rate	0 - 2800 min ⁻¹ / 0 - 44500 min ⁻¹
Drilling capacity, wood	30 mm
Drilling capacity, concrete	14 mm
Drilling capacity, steel	12 mm
Drill chuck	13 mm
Housing length	217 mm
Product weight	1.8 kg (excl. battery)
Number of batteries / chargers included in the scope of delivery	0 pcs / 0 pcs
Additional handle	•
Metal depth stop	•
Packaging	Colour box
Article number	4514026 



1x 18 V

∅ 6 mm / 45 mm into brick – max. quantity per battery charge

2.0 Ah 80 pcs	2.5 Ah 100 pcs	3.0 Ah 115 pcs	4.0 Ah 160 pcs	5.2 Ah 205 pcs	6.0 Ah 230 pcs	8.0 Ah 320 pcs
-------------------------	--------------------------	--------------------------	--------------------------	--------------------------	--------------------------	--------------------------

Matching accessories

Drill bit cassette set, 15-piece: 3 drill bit cassettes, each containing 5 drill bits (for stone, metal and wood)	49109157	
---	----------	---

**BRUSHLESS
COMPACT**

- High performance**
44,500 impacts/min
14 mm drilling capacity in concrete
- Compact design**
217 mm housing length
- 2 functions**
drilling
impact drilling
- 13 mm chuck**
quick-release system
metal construction
- Anti-kickback**
protection against injury in the event of kickback



**PROFESSIONAL
CORDLESS ROTARY HAMMER
TP-HD 18/17-C Li Brushless +5**

NEW



**BRUSHLESS
COMPACT**

PXC battery voltage	18 V
Battery charging time 18 V / 3.0 Ah	45 min (4 A charger)
Idle speed / blow rate / impact force	0 - 1530 min ⁻¹ / 0 - 5350 min ⁻¹ / 1.7 J
Drilling capacity, concrete	17 mm
Drill chuck	SDS-plus
Product weight	1.7 kg (excl. battery)
Number of batteries / chargers included in the scope of delivery	1 pcs (18 V 3.0 Ah Sealed Li-Ion) / 1 pcs (4 A Charger)
Additional handle	•
Metal depth stop	•
Accessories	Drill bit set, 5-pc (5, 6, 8, 10, 12 mm)
Packaging	E-Case
Article number	4514418 

**PROFESSIONAL
CORDLESS ROTARY HAMMER
TP-HD 18/17-C Li Brushless**

Same as previous item, but excl. batteries / chargers / drill bit set / E-Case

Number of batteries / chargers included in the scope of delivery	0 pcs / 0 pcs
Additional handle	•
Metal depth stop	•
Packaging	Colour box
Article number	4514415 

1x 18 V

Drilling in concrete (ø 6 mm / 50 mm) – max. quantity per battery charge

2.0 Ah	2.5 Ah	3.0 Ah	4.0 Ah	5.2 Ah	6.0 Ah	8.0 Ah
48 holes	60 holes	71 holes	97 holes	124 holes	144 holes	192 holes



**PROFESSIONAL
CORDLESS CUT-OFF GRINDER 76 MM**
TP-CO 18/76-C Li Brushless



**BRUSHLESS
COMPACT**

PXC battery voltage	18 V
Idle speed	20.000 min ⁻¹
Wheel diameter	76 mm
Max. cutting depth	16 mm
Product weight	0.7 kg (excl. battery)
Number of batteries / chargers included in the scope of delivery	0 pcs / 0 pcs
Accessories	3 cutting wheels for metalworking, 1 diamond cutting wheel, 1 hex key
Packaging	Colour box
Article number	4432000 

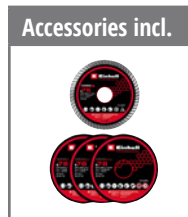



1x 18 V

Cutting sheet metal (0.5 mm) – max. cutting capacity per battery charge

2.0 Ah	2.5 Ah	3.0 Ah	4.0 Ah	5.2 Ah	6.0 Ah	8.0 Ah
14 m	18 m	21 m	28 m	36 m	41 m	55 m

Matching accessories

Diamond Cutting Wheel 76 x 1.7 mm	4440470	
Cutting Wheel Set, 5-piece, 76 mm	4440471	



PROFESSIONAL CORDLESS CIRCULAR SAW TP-CS 18/136-C Li Brushless



**BRUSHLESS
COMPACT**



PXC battery voltage	18 V
Idle speed	4000 min ⁻¹
Saw blade	Ø 136 x 20 mm
Cutting depth 90°	51 mm
Cutting depth 45°	35 mm
Product weight	2.4 kg (excl. battery)
Number of batteries / chargers included in the scope of delivery	0 pcs / 0 pcs
Accessories	Parallel stop
Packaging	Colour box
Article number	4331240 

1x 18 V

19 mm chipboard – max. cutting capacity per battery charge

2.0 Ah	2.5 Ah	3.0 Ah	4.0 Ah	5.2 Ah	6.0 Ah	8.0 Ah
28 m	35 m	42 m	56 m	73 m	84 m	112 m

Matching accessories

Guide Bar Aluminium 2x 1000 mm	4502118	
Saw blade for woodworking, TCT Ø 136 x Ø 20 x 1.8 mm, t16	4502077	



POWER X CHANGE

PROFESSIONAL CORDLESS POWER TOOLS



Operating times

The product descriptions specify the operating times that the devices can achieve when using the various batteries.

2.0 Ah	2.5 Ah	3.0 Ah	4.0 Ah	5.2 Ah	6.0 Ah	8.0 Ah
160 pcs	200 pcs	240 pcs	320 pcs	420 pcs	480 pcs	640 pcs

For optimum performance of the devices, we recommend the batteries with operating times highlighted in dark grey

Einhell Accessories

Accessories from the Einhell Accessories range are marked with

A

PROFESSIONAL CORDLESS DRILL WITH IMPACT FUNCTION

TP-CD 18/130-K Li-i Brushless

NEW

PXC battery voltage	18 V
Idle speed	0 - 500 / 0 - 2100 min ⁻¹
Blow rate	0 - 7150 / 0 - 27300 min ⁻¹
Torque (hard)	130 Nm
Torque settings	21+1+1
Drill chuck	13 mm
Housing length	201 mm
Product weight	1.7 kg (excl. battery)
Number of batteries / chargers included in the scope of delivery	0 pcs / 0 pcs
Additional handle	•
Depth stop	•
Packaging	Colour box
Article number	4514313



BRUSHLESS

1x 18 V

Screwing 6 x 60 mm screws into soft wood – max. quantity per battery charge

2.0 Ah	2.5 Ah	3.0 Ah	4.0 Ah	5.2 Ah	6.0 Ah	8.0 Ah
205 pcs	255 pcs	305 pcs	410 pcs	530 pcs	610 pcs	820 pcs

- 3 functions**
screwing
drilling
impact drilling
- Brushless motor**
for power that lasts
- 13 mm drill chuck**
quick release system
metal
- 2-speed gearbox**
120 Nm torque
21 torque stages
- Additional handle**
joint-gentle working
- LED light**
optimal illumination



PROFESSIONAL CORDLESS DRILL WITH IMPACT FUNCTION TP-CD 18/120 Li-i Brushless

PXC battery voltage	18 V
Idle speed	0 - 500 / 0 - 2100 min ⁻¹
Blow rate	0 - 6500 / 0 - 27300 min ⁻¹
Torque (hard)	120 Nm
Torque settings	21+1+1
Drill chuck	13 mm
Housing length	201 mm
Product weight	1.7 kg (excl. battery)
Number of batteries / chargers included in the scope of delivery	0 pcs / 0 pcs
Additional handle	•
Depth stop	•
Packaging	Colour box
Article number	4514310



1x 18 V

Screwing 6 x 60 mm screws into soft wood – max. quantity per battery charge

2.0 Ah	2.5 Ah	3.0 Ah	4.0 Ah	5.2 Ah	6.0 Ah	8.0 Ah
190 pcs	240 pcs	335 pcs	445 pcs	580 pcs	670 pcs	895 pcs

BRUSHLESS



PROFESSIONAL CORDLESS DRILL WITH IMPACT FUNCTION TP-CD 18/80 Li-i Brushless

PXC battery voltage	18 V
Battery charging time 18 V / 2.0 Ah	40 min
Idle speed	0 - 500 / 0 - 1800 min ⁻¹
Blow rate	0 - 8000 / 0 - 28800 min ⁻¹
Torque (hard)	80 Nm
Torque settings	20+1+1
Drill chuck	13 mm
Housing length	199 mm
Product weight	1.4 kg (excl. battery)
Number of batteries / chargers included in the scope of delivery	2 pcs (18 V 2.0 Ah Li-Ion) / 1 pc
Additional handle	•
Packaging	E-Case
Article number	4514306



Accessories incl.



1x 18 V

Screwing 6 x 60 mm screws into soft wood – max. quantity per battery charge

2.0 Ah	2.5 Ah	3.0 Ah	4.0 Ah	5.2 Ah	6.0 Ah	8.0 Ah
280 pcs	350 pcs	420 pcs	560 pcs	730 pcs	840 pcs	1120 pcs

PROFESSIONAL CORDLESS DRILL WITH IMPACT FUNCTION TP-CD 18/80 Li-i Brushless

Same as previous item, but without battery(ies) / charger(s)

Number of batteries / chargers included in the scope of delivery	0 pcs / 0 pcs
Additional handle	•
Packaging	Colour box
Article number	4514305



BRUSHLESS

- Brushless Motor**
powerful and durable
- 3 functions**
screwing
drilling
impact drilling
- 13 mm drill chuck**
Quick clamping system
Metal construction
- 2-speed transmission**
80 Nm torque
20 torque settings
- LED light**
optimal illumination
- Additional handle**
Makes operation easy on your joints



PROFESSIONAL CORDLESS DRILL WITH IMPACT FUNCTION

TP-CD 18/70 Li-i Brushless

PXC battery voltage	18 V
Battery charging time 18 V / 2.0 Ah/3.0 Ah	40 min / 60 min
Idle speed	0 - 500 / 0 - 2000 min ⁻¹
Blow rate	0 - 8000 / 0 - 32000 min ⁻¹
Torque (hard)	70 Nm
Torque settings	21+1+1
Drill chuck	13 mm
Housing length	205 mm
Product weight	1.3 kg (excl. battery)
Number of batteries / chargers included in the scope of delivery	2 pcs (1x 18 V 2.0 Ah Li-Ion, 1x 18 V 3.0 Ah+ Li-Ion) / 1 pc
Additional handle	•
Accessories	70-piece
Packaging	E-Case
Article number	4514318



1x 18 V

Screwing 6 x 60 mm screws into soft wood – max. quantity per battery charge

2.0 Ah	2.5 Ah	3.0 Ah	4.0 Ah	5.2 Ah	6.0 Ah	8.0 Ah
290 pcs	360 pcs	430 pcs	580 pcs	750 pcs	860 pcs	1160 pcs

BRUSHLESS

Accessories incl.



TESTSIEGER



- 3 functions: screwdriving, drilling, impact drilling
- 2-speed transmission: 70 Nm, 21 torque settings
- Brushless motor: durable and powerful
- 13 mm chuck: quick-release system, metal construction
- LED light: optimum illumination
- Set with accessories, batteries and case



PROFESSIONAL CORDLESS DRILL WITH IMPACT FUNCTION

TP-CD 18/70 Li-i Brushless

Same as previous item, but incl. 2 batteries (18 V | 2.0 Ah | Li-Ion), 1 charger, E-Case

Number of batteries / chargers included in the scope of delivery	2 pcs (18 V 2.0 Ah Li-Ion) / 1 pc	
Additional handle	•	
Packaging	E-Case	
Article number	4514316	 4 006825 677904

Accessories incl.



PROFESSIONAL CORDLESS DRILL WITH IMPACT FUNCTION

TP-CD 18/70 Li-i Brushless

Same as previous item, but without battery(ies) / charger(s)

Number of batteries / chargers included in the scope of delivery	0 pcs / 0 pcs	
Additional handle	•	
Packaging	Colour box	
Article number	4514315	 4 006825 677898



PROFESSIONAL CORDLESS DRILL WITH IMPACT FUNCTION

TP-CD 18/60 Li-i Brushless

PXC battery voltage	18 V
Idle speed	0 - 500 / 0 - 2000 min ⁻¹
Blow rate	0 - 8000 / 0 - 32000 min ⁻¹
Torque (hard)	60 Nm
Torque settings	21+1+1
Drill chuck	13 mm
Housing length	205 mm
Product weight	1.3 kg (excl. battery)
Number of batteries / chargers included in the scope of delivery	0 pcs / 0 pcs
Additional handle	•
Packaging	Colour box
Article number	4514205



1x 18 V

Screwing 6 x 60 mm screws into soft wood – max. quantity per battery charge

2.0 Ah	2.5 Ah	3.0 Ah	4.0 Ah	5.2 Ah	6.0 Ah	8.0 Ah
350 pcs	440 pcs	530 pcs	700 pcs	920 pcs	1060 pcs	1400 pcs

BRUSHLESS

2-speed transmission
60 Nm
21 torque settings

13 mm drill chuck
Quick-release system
Metal construction

LED light
optimal illumination

Ergonomic design
auxiliary handle

3 functions
□ Δ Screwdriving
Conventional drilling
Impact drilling



PROFESSIONAL CORDLESS DRILL WITH IMPACT FUNCTION TP-CD 18/60 Li-i Brushless

PXC battery voltage	18 V
Battery charging time 18 V / 2.0 Ah	40 min
Idle speed	0 - 500 / 0 - 1800 min ⁻¹
Blow rate	0 - 8000 / 0 - 28800 min ⁻¹
Torque (hard)	60 Nm
Torque settings	20+1+1
Drill chuck	13 mm
Housing length	190 mm
Product weight	1.3 kg (excl. battery)
Number of batteries / chargers included in the scope of delivery	1 pc (18 V 2.0 Ah Li-Ion) / 1 pc
Packaging	E-Box
Article number	4514211



1x 18 V

Screwing 6 x 60 mm screws into soft wood – max. quantity per battery charge

2.0 Ah	2.5 Ah	3.0 Ah	4.0 Ah	5.2 Ah	6.0 Ah	8.0 Ah
390 pcs	485 pcs	600 pcs	780 pcs	1040 pcs	1200 pcs	1560 pcs



Accessories incl.



BRUSHLESS

PROFESSIONAL CORDLESS DRILL WITH IMPACT FUNCTION TP-CD 18/60-T Li-i Brushless

Same as previous item, but without battery(ies) / charger(s)

Number of batteries / chargers included in the scope of delivery	0 pcs / 0 pcs
Packaging	Colour box
Article number	4514237



- 3 functions**
 - Screwing
 - Drilling
 - Impact drilling
- 2-speed gearbox**
 - 60 Nm torque
 - 21 torque settings
- 13 mm chuck**
 - Quick-release system
 - Metal construction
- Brushless motor**
 - powerful and durable
- LED light**
 - optimal illumination



PROFESSIONAL CORDLESS DRILL WITH IMPACT FUNCTION TP-CD 18/50 Li-i Brushless

PXC battery voltage	18 V
Battery charging time 18 V / 2.0 Ah	40 min
Idle speed	0 - 500 / 0 - 1800 min ⁻¹
Blow rate	0 - 8000 / 0 - 28800 min ⁻¹
Torque (hard)	50 Nm
Torque settings	20+1+1
Drill chuck	13 mm
Housing length	190 mm
Product weight	1.2 kg (excl. battery)
Number of batteries / chargers included in the scope of delivery	2 pcs (18 V 2.0 Ah Li-Ion) / 1 pc
Packaging	E-Box
Article number	4513940



Accessories incl.



1x 18 V

Screwing 6 x 60 mm screws into soft wood – max. quantity per battery charge

2.0 Ah	2.5 Ah	3.0 Ah	4.0 Ah	5.2 Ah	6.0 Ah	8.0 Ah
320 pcs	400 pcs	480 pcs	640 pcs	830 pcs	960 pcs	1280 pcs

PROFESSIONAL CORDLESS DRILL WITH IMPACT FUNCTION TP-CD 18/50 Li-i Brushless

Same as previous item, but without battery(ies) / charger(s)

Number of batteries / chargers included in the scope of delivery	0 pcs / 0 pcs
Packaging	Colour box
Article number	4513942



BRUSHLESS

- 3 functions: screwing, drilling, impact drilling
- 2-speed gearbox: 50 Nm torque, 20 torque settings
- Quick-action drill chuck: 13 mm metal drill chuck
- Brushless motor: durable and powerful
- LED light: optimal lighting
- Complete set: with batteries, charger and case



PROFESSIONAL CORDLESS DRILL TP-CD 18/80 Li Brushless

PXC battery voltage	18 V
Idle speed	0 - 500 / 0 - 1800 min ⁻¹
Torque (hard)	80 Nm
Torque settings	19+1
Drill chuck	13 mm
Housing length	194 mm
Product weight	1.4 kg (excl. battery)
Number of batteries / chargers included in the scope of delivery	0 pcs / 0 pcs
Additional handle	•
Packaging	Colour box
Article number	4514300



1x 18 V

Screwing 6 x 60 mm screws into soft wood – max. quantity per battery charge

2.0 Ah	2.5 Ah	3.0 Ah	4.0 Ah	5.2 Ah	6.0 Ah	8.0 Ah
280 pcs	350 pcs	420 pcs	560 pcs	730 pcs	840 pcs	1120 pcs



BRUSHLESS

- 2-speed transmission**
80 Nm torque
19 torque levels
1 drilling setting
- Brushless motor**
powerful and durable
- Quick-action chuck**
13 mm metal drill chuck
- Additional handle**
sturdy & ergonomic
- LED light**
optimal illumination
- Electronic speed control**
responsive screwing and drilling



PROFESSIONAL CORDLESS DRILL TP-CD 18/60 Li Brushless

PXC battery voltage	18 V
Idle speed	0 - 500 / 0 - 2000 min ⁻¹
Torque (hard)	60 Nm
Torque settings	21+1
Drill chuck	13 mm
Housing length	193 mm
Product weight	1.3 kg (excl. battery)
Number of batteries / chargers included in the scope of delivery	0 pcs / 0 pcs
Additional handle	•
Packaging	Colour box
Article number	4514210



1x 18 V

Screwing 6 x 60 mm screws into soft wood – max. quantity per battery charge

2.0 Ah	2.5 Ah	3.0 Ah	4.0 Ah	5.2 Ah	6.0 Ah	8.0 Ah
350 pcs	440 pcs	530 pcs	700 pcs	920 pcs	1060 pcs	1400 pcs

BRUSHLESS

- 2-speed transmission**
60 Nm
21 torque levels
1 drilling setting
- Brushless motor**
powerful and durable
- Quick-release chuck**
13 mm metal drill chuck
- Ergonomic design**
auxiliary handle
- LED light**
optimal illumination
- Speed control electronics**
adapts the tool to the material at hand



PROFESSIONAL CORDLESS DRILL TP-CD 18/50 Li Brushless

PXC battery voltage	18 V
Battery charging time 18 V / 2.0 Ah	40 min
Idle speed	0 - 500 / 0 - 1800 min ⁻¹
Torque (hard)	50 Nm
Torque settings	19+1
Drill chuck	13 mm
Housing length	185 mm
Product weight	1.2 kg (excl. battery)
Number of batteries / chargers included in the scope of delivery	2 pcs (18 V 2.0 Ah Li-Ion) / 1 pc
Packaging	E-Box
Article number	4513896



Accessories incl.



1x 18 V

Screwing 6 x 60 mm screws into soft wood – max. quantity per battery charge

2.0 Ah	2.5 Ah	3.0 Ah	4.0 Ah	5.2 Ah	6.0 Ah	8.0 Ah
320 pcs	400 pcs	480 pcs	640 pcs	830 pcs	960 pcs	1280 pcs

PROFESSIONAL CORDLESS DRILL TP-CD 18/50 Li Brushless

Same as previous item, but without battery(ies) / charger(s)

Number of batteries / chargers included in the scope of delivery	0 pcs / 0 pcs
Packaging	Colour box
Article number	4513887



BRUSHLESS

- Quick-release chuck**
13 mm chuck
- Brushless motor**
durable and powerful
- 2-speed gearbox**
50 Nm torque
19 torque settings
1 drilling set
- Ergonomic design**
with softgrip
- LED light**
optimal lighting
- Complete set**
with batteries, charger and case



Cordless Drills Accessories

Type	Article number	EAN	Items supplied	Packaging
Drills and Bits Set	49108806	4 009311 088062	22-piece: 12 bits, 5 metal drill bits, 3 socket spanner inserts, 1 countersink, 1 quick change bit holder	Storage case
Drills and Bits Set	49108911	4 009311 089113	39-piece: 24 bits, 8 metal drill bits, 5 socket spanner inserts, 1 countersink, 1 quick change bit holder	Storage case
Drills and Bits Set	49108956	4 009311 089564	39-piece: 24 bits, 8 metal drill bits (2x stone, 3x metal, 3x wood), 5 socket spanner inserts, 1 countersink, 1 quick change bit holder	Storage case
Bits Set	49108801	4 009311 088017	34-piece: 29 bits, 3 socket spanner inserts, 1 countersink, 1 quick change bit holder	Storage case
Set of Drill Bit Cassettes	49109157	4 009311 091574	15-piece: 3 drill bit cassettes with 5 drill bits in each (stone, metal, wood)	Drill bit cassettes



PROFESSIONAL CORDLESS DRYWALL SCREWDRIVER TP-DY 18 Li Brushless

PXC battery voltage	18 V	
Idle speed	0 - 5000 min ⁻¹	
Bit mount	Internal hexagon 6.35 mm (1/4")	
Product weight	0.9 kg (excl. battery)	
Number of batteries / chargers included in the scope of delivery	0 pcs / 0 pcs	
Accessories	1x magazine attachment, 1x bit type PH2 (long)	
Packaging	E-Case	
Article number	4261012	 4 006825 680614

1x 18 V

Screwing 3.9 x 25 mm screws into drywall – max. quantity per battery charge

2.0 Ah	2.5 Ah	3.0 Ah	4.0 Ah	5.2 Ah	6.0 Ah	8.0 Ah
1400 pcs	1800 pcs	2200 pcs	2800 pcs	3650 pcs	4400 pcs	5800 pcs



BRUSHLESS

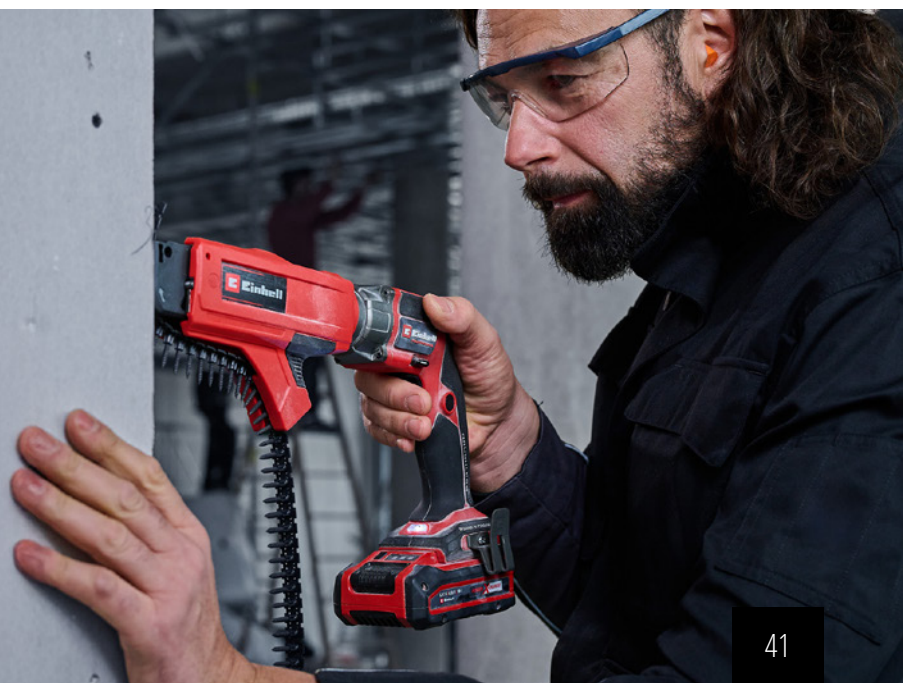

PROFESSIONAL CORDLESS DRYWALL SCREWDRIVER

TP-DY 18 Li Brushless

Same as previous item, but incl. E-Box, excl. batteries / chargers







Number of batteries / chargers included in the scope of delivery	0 pcs / 0 pcs	
Accessories	1x bit type PH2	
Packaging	E-Box	
Article number	4261010	

Cordless Drywall Screwdriver Accessory



Magazine Attachment (screw length 25 - 55 mm, max. Ø 3.9 mm) incl. 1x bit Typ PH2	4259955	
---	---------	---

Magazine Attachment Accessory

Drywall Bit Set (3x PH2 bits)	4259956	
Drywall Screw Belt Set (20 belts with 50 screws each, dimensions 3.5 x 35 mm, coarse thread)	4261002	
Drywall Screw Belt Set (20 belts with 50 screws each, dimensions 3.5 x 45 mm, coarse thread)	4261004	
Drywall Screw Belt Set (20 belts with 50 screws each, dimensions 3.5 x 25 mm, fine thread)	4261000	
Drywall Screw Belt Set (20 belts with 50 screws each, dimensions 3.5 x 35 mm, fine thread)	4261001	
Drywall Screw Belt Set (20 belts with 50 screws each, dimensions 3.5 x 35 mm, fine thread with self-drilling tip)	4261003	



PROFESSIONAL CORDLESS RIVET GUN TP-RG 18/30 Li Brushless

NEW



PXC battery voltage	18 V
Max. pulling force	20000 N
Stroke length	30 mm
Rivet diameter	2.4 - 6.4 mm
Product weight	1.8 kg (excl. battery)
Number of batteries / chargers included in the scope of delivery	0 pcs / 0 pcs
Accessories	Clamping wrench, 5x mouth pieces (2.4 mm 3.2 mm 4.0 mm 4.8 mm 6.4 mm)
Packaging	Colour box
Article number	4522400 

1x 18 V

Insert steel rivets (3.2 mm) – max. quantity per battery charge

2.0 Ah	2.5 Ah	3.0 Ah	4.0 Ah	5.2 Ah	6.0 Ah	8.0 Ah
680 pcs	850 pcs	1020 pcs	1360 pcs	1768 pcs	2040 pcs	2720 pcs

Matching accessories

Clamping Jaw Set Rivet Gun	4522401 
----------------------------	---

Accessories incl.



BRUSHLESS



PROFESSIONAL CORDLESS IMPACT DRIVER IMPAXXO 18/450

PXC battery voltage	18 V
Idle speed (step 1 / 2 / 3)	0 - 1000 / 0 - 1500 / 0 - 2100 min ⁻¹
Torque (stage 1 / 2 / 3)	200 / 280 / 450 Nm
Loosening torque (max.)	800 Nm
Number of torque settings	3
Tool mounting	External square (1/2")
Housing length	205 mm
Product weight	2.0 kg (excl. battery)
Number of batteries / chargers included in the scope of delivery	0 pcs / 0 pcs
Accessories	Bit adapter, 3-piece nut set
Packaging	Colour box
Article number	4510070



1x 18 V

Max. number of wheel bolts (hexagon head, wrench size 22 mm, tightened to 120 Nm) that can be released per battery charge

2.0 Ah	2.5 Ah	3.0 Ah	4.0 Ah	5.2 Ah	6.0 Ah	8.0 Ah
760 pcs	950 pcs	1140 pcs	1520 pcs	1975 pcs	2280 pcs	3040 pcs



Accessories incl.



BRUSHLESS



PROFESSIONAL CORDLESS IMPACT DRIVER IMPAXXO 18/230

PXC battery voltage	18 V
Idle speed	0 - 2900 min ⁻¹
Torque (max.)	230 Nm
Loosening torque (max.)	450 Nm
Tool mounting	External square (1/2")
Housing length	166 mm
Product weight	1.1 kg (excl. battery)
Number of batteries / chargers included in the scope of delivery	0 pcs / 0 pcs
Accessories	Bit adapter
Packaging	Colour box
Article number	4510080



1x 18 V

Max. number of wheel bolts (hexagon head, wrench size 22 mm, tightened to 120 Nm) that can be released per battery charge

2.0 Ah	2.5 Ah	3.0 Ah	4.0 Ah	5.2 Ah	6.0 Ah	8.0 Ah
635 pcs	795 pcs	950 pcs	1270 pcs	1650 pcs	1905 pcs	2540 pcs



Accessories incl.



BRUSHLESS



PROFESSIONAL CORDLESS IMPACT DRIVER TP-CI 18/220 Li Brushless

PXC battery voltage	18 V
Idle speed	0 - 2900 min ⁻¹
Torque (max.)	220 Nm
Tool mounting	Internal hexagon 6.35 mm (1/4")
Housing length	157 mm
Product weight	1.1 kg (excl. battery)
Number of batteries / chargers included in the scope of delivery	0 pcs / 0 pcs
Packaging	Colour box
Article number	4510085 



1x 18 V

Screwing 6 x 60 mm screws into soft wood – max. quantity per battery charge

2.0 Ah	2.5 Ah	3.0 Ah	4.0 Ah	5.2 Ah	6.0 Ah	8.0 Ah
215 pcs	260 pcs	320 pcs	430 pcs	555 pcs	640 pcs	860 pcs

BRUSHLESS



PROFESSIONAL CORDLESS ROTARY HAMMER TP-HD 36/30 Li Brushless +4



BRUSHLESS

PXC battery voltage	2x 18 V
Idle speed / blow rate / impact force	0 - 1100 min ⁻¹ / 0 - 5300 min ⁻¹ / 3.5 J
Drilling capacity, concrete	30 mm
Drill chuck	SDS-plus
Product weight	3.4 kg (excl. batteries)
Number of batteries / chargers included in the scope of delivery	0 pcs / 0 pcs
Additional handle	•
Metal depth stop	•
Accessories	3 SDS-plus drill bits / 1 SDS-plus flat chisel
Packaging	E-Box
Article number	4513983



4 006825 674033

2x 18 V

Drilling in concrete (ø 8 mm / 50 mm) – max. quantity per battery charge

2.0 Ah	2.5 Ah	3.0 Ah	4.0 Ah	5.2 Ah	6.0 Ah	8.0 Ah
79 holes	105 holes	126 holes	169 holes	222 holes	276 holes	340 holes

Accessories incl.



4 modes
 Chiselling with rotation stop
 Chiselling without rotation stop
 Percussion drilling
 Conventional drilling

Electronic speed control
 Finely adjustable

Brushless motor
 powerful and durable

Twin-Pack technology
 36 V battery power

Chuck
 SDS-Plus

Pneumatic impact mechanism
 3.5 joules
 30 mm drilling capacity in concrete



**PROFESSIONAL
CORDLESS ROTARY HAMMER
TP-HD 18/28 Li Brushless +4**



PXC battery voltage	18 V
Battery charging time 18 V / 3.0 Ah	60 min
Idle speed / blow rate / impact force	0 - 1200 min ⁻¹ / 0 - 5500 min ⁻¹ / 3.0 J
Drilling capacity, concrete	28 mm
Drill chuck	SDS-plus
Product weight	3.7 kg (excl. battery)
Number of batteries / chargers included in the scope of delivery	1 pcs (18 V 3.0 Ah+ Li-Ion) / 1 pcs
Additional handle	•
Metal depth stop	•
Accessories	3 SDS-plus drill bits / 1 SDS-plus flat chisel
Packaging	E-Case
Article number	4514274



BRUSHLESS

1x 18 V

Drilling in concrete (ø 6 mm / 50 mm) – max. quantity per battery charge

2.0 Ah	2.5 Ah	3.0 Ah	4.0 Ah	5.2 Ah	6.0 Ah	8.0 Ah
32 holes	40 holes	50 holes	65 holes	80 holes	92 holes	125 holes

Accessories incl.



Chuck
SDS-Plus
semi-automatic operation

4 modes
chiselling with rotation stop
chiselling without rotation stop
impact drilling
drilling

Pneumatic impact mechanism
3.0 J
28 mm drilling capacity in concrete

Brushless motor
powerful and durable



PROFESSIONAL CORDLESS ROTARY HAMMER TP-HD 18/26 Li Brushless



BRUSHLESS

PXC battery voltage	18 V
Idle speed / blow rate / impact force	0 - 1200 min ⁻¹ / 0 - 5500 min ⁻¹ / 2.6 J
Drilling capacity, concrete	26 mm
Drill chuck	SDS-plus
Product weight	3.1 kg (excl. battery)
Number of batteries / chargers included in the scope of delivery	0 pcs / 0 pcs
Additional handle	•
Metal depth stop	•
Packaging	E-Case
Article number	4514265 

1x 18 V

Drilling in concrete (ø 6 mm / 50 mm) – max. quantity per battery charge

2.0 Ah	2.5 Ah	3.0 Ah	4.0 Ah	5.2 Ah	6.0 Ah	8.0 Ah
32 holes	40 holes	50 holes	65 holes	80 holes	92 holes	125 holes

Accessories incl.



- 4 modes**
 - Chiselling with/without rotation stop
 - Impact drilling
 - Conventional drilling
- Speed control electronics** adapts tool to material at hand
- Main handle** vibration damped
- Chuck** SDS-Plus semi-automatic operation
- Brushless motor** powerful and durable



PROFESSIONAL CORDLESS ROTARY HAMMER HEROCCO 18/20



BRUSHLESS

PXC battery voltage	18 V
Idle speed / blow rate / impact force	0 - 1200 min ⁻¹ / 0 - 5500 min ⁻¹ / 2.2 J
Drilling capacity, concrete	20 mm
Drill chuck	SDS-plus
Product weight	2.1 kg (excl. battery)
Number of batteries / chargers included in the scope of delivery	0 pcs / 0 pcs
Additional handle	•
Metal depth stop	•
Accessories	1 magnetic bit adapter
Packaging	E-Box
Article number	4513900



1x 18 V

Screwing 6 x 60 mm screws into soft wood – max. quantity per battery charge

2.0 Ah	2.5 Ah	3.0 Ah	4.0 Ah	5.2 Ah	6.0 Ah	8.0 Ah
335 pcs	417 pcs	500 pcs	670 pcs	870 pcs	1000 pcs	1340 pcs

Drilling in concrete (ø 6 mm / 50 mm) – max. quantity per battery charge

87 holes	108 holes	130 holes	174 holes	225 holes	260 holes	348 holes
----------	-----------	-----------	-----------	-----------	-----------	-----------

Accessories incl.



PROFESSIONAL CORDLESS ROTARY HAMMER D-HANDLE TP-HD 18/26 D Li Brushless



BRUSHLESS

PXC battery voltage	18 V
Idle speed / blow rate / impact force	0 - 1150 min ⁻¹ / 0 - 5100 min ⁻¹ / 2.6 J
Drilling capacity, concrete	26 mm
Drill chuck	SDS-plus
Product weight	2.9 kg (excl. battery)
Number of batteries / chargers included in the scope of delivery	0 pcs / 0 pcs
Additional handle	•
Metal depth stop	•
Packaging	E-Case
Article number	4514270



1x 18 V

Drilling in concrete (ø 6 mm / 50 mm) – max. quantity per battery charge

2.0 Ah	2.5 Ah	3.0 Ah	4.0 Ah	5.2 Ah	6.0 Ah	8.0 Ah
36 holes	45 holes	54 holes	72 holes	94 holes	108 holes	144 holes

Accessories incl.



E-CASE SYSTEM

- Brushless motor**
durable and powerful
- 4 modes**
chiselling with rotation stop
chiselling without rotation stop
percussion drilling
drilling
- Speed electronics**
precise control
- Ergonomic Design**
D-Handle
Auxiliary Handle
- Chuck**
SDS-Plus
semi-automatic operation
- Pneumatic impact**
2.6 Joule
26 mm drilling in concrete



PROFESSIONAL CORDLESS ROTARY HAMMER D-HANDLE TP-HD 18/22 D Li Brushless



BRUSHLESS

PXC battery voltage	18 V
Idle speed / blow rate / impact force	0 - 1800 min ⁻¹ / 0 - 5150 min ⁻¹ / 2.3 J
Drilling capacity, concrete	22 mm
Drill chuck	SDS-plus
Product weight	2.1 kg (excl. battery)
Number of batteries / chargers included in the scope of delivery	0 pcs / 0 pcs
Additional handle	•
Metal depth stop	•
Packaging	E-Case
Article number	4514277



1x 18 V

Drilling in concrete (ø 6 mm / 50 mm) – max. quantity per battery charge

2.0 Ah	2.5 Ah	3.0 Ah	4.0 Ah	5.2 Ah	6.0 Ah	8.0 Ah
57 holes	75 holes	85 holes	113 holes	147 holes	170 holes	227 holes

Accessories incl.



Cordless Rotary Hammer (SDS-plus) Accessory

Type	Article number	EAN	Items supplied	Packaging
SDS-plus drill bits/chisels set	49240295	4 009312 402959	10 hammer drill bits (5 - 16 mm), 2 chisels (1x flat 20 mm, 1x pointed)	Storage case
SDS-plus drill bits set	49240281	4 009312 402812	12 hammer drill bits (5 - 14 mm)	Storage case

Pneumatic impact mechanism
2.3 Joules
22 mm drilling capacity in concrete

Brushless motor
powerful and durable

Speed control electronics
adapts the tool to the material

Tool holder
SDS-Plus semi-automatic operation

4 modes

- Chiselling with rotation stop
- Chiselling without rotation stop
- Percussion drilling
- Conventional drilling



PROFESSIONAL CORDLESS DEMOLITION HAMMER TP-DH 18/4 Li Brushless



BRUSHLESS

PXC battery voltage	18 V
Blow rate	4600 min ⁻¹
Impact force	4 J
Drill chuck	SDS-plus
Product weight	2.9 kg (excl. battery)
Number of batteries / chargers included in the scope of delivery	0 pcs / 0 pcs
Additional handle	•
Accessories	1 pointed chisel, 1 flat chisel
Packaging	E-Case
Article number	4514190



Accessories incl.



1x 18 V

Chiseling hollow brick stone with pointed chisel – max. operating time per battery charge

2.0 Ah	2.5 Ah	3.0 Ah	4.0 Ah	5.2 Ah	6.0 Ah	8.0 Ah
15 min	19 min	23 min	30 min	39 min	45 min	60 min

- SDS Plus Mount**
16 x chisel adjustment
- Ergonomic design**
vibration-damped handle
- Impact power**
4 J
powerful and compact
- LED light**
optimum illumination
- Impact rate control**
material-appropriate operations



PROFESSIONAL CORDLESS PAINT/MORTAR MIXER TP-MX 18-2 Li Brushless

PXC battery voltage	18 V
Idle speed	0 - 450 / 0- 720 min ⁻¹
Stirrer mount	M14
Product weight	3.8 kg (excl. battery / excl. stirrer)
Number of batteries / chargers included in the scope of delivery	0 pcs / 0 pcs
Accessories	1 mortar mixer (ø 120 mm)
Packaging	Colour box
Article number	4258770



BRUSHLESS

1x 18 V

Max. operating time per battery charge in idle mode

2.0 Ah	2.5 Ah	3.0 Ah	4.0 Ah	5.2 Ah	6.0 Ah	8.0 Ah
16 min	22 min	26 min	34 min	46 min	52 min	68 min

Mixing duration for wall paint per battery charge

14 min	18 min	21 min	28 min	37 min	42 min	56 min
--------	--------	--------	--------	--------	--------	--------

Mixing duration for mortar per battery charge

11 min	14 min	16 min	22 min	28 min	32 min	44 min
--------	--------	--------	--------	--------	--------	--------

Accessories incl.



Matching accessories

Mortar Mixer	49497625	
Paint Mixer	49497635	
Mixer Set (1 paint, 1 mortar mixer)	49497695	

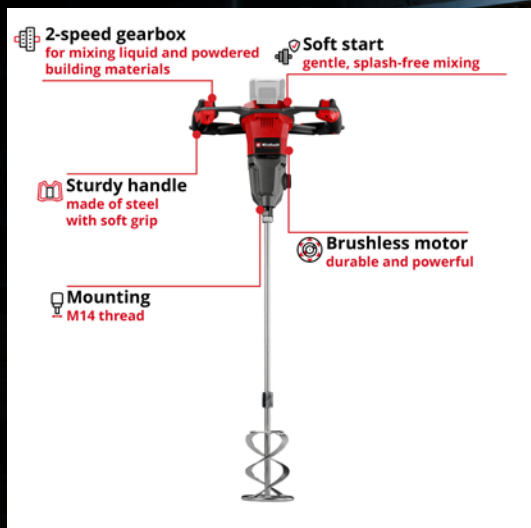

PROFESSIONAL CORDLESS GREASE GUN TP-GR 18/690 Li

NEW

PXC battery voltage	18 V
Max. pressure	690 bar
Discharge volume max.	295 ml/min
Volume control	15
Hose length	120 cm
Hose / filling connection thread	1/8" NPTF
Product weight	3.9 kg (excl. battery)
Number of batteries / chargers included in the scope of delivery	0 pcs / 0 pcs
Accessories	Carrying strap, hose (120 cm), mouthpiece 1/8" NPTF
Packaging	Colour box
Article number	4522300 





1x 18 V

Maximum number of grease cartridges (400 g) per battery charge in stage 1						
2.0 Ah	2.5 Ah	3.0 Ah	4.0 Ah	5.2 Ah	6.0 Ah	8.0 Ah
7 pcs	8 pcs	10 pcs	13 pcs	17 pcs	20 pcs	26 pcs
Maximum number of grease cartridges (400 g) per battery charge in stage 2						
9 pcs	11 pcs	14 pcs	18 pcs	23 pcs	27 pcs	36 pcs



Cordless Grease Guns Accessories

Type	Article number	EAN	Cartridge volume	Cartridge type	Spanner size	Internal thread	External thread
Grease Cartridge Adapter 500 g	4522301		500 g	Thread	30 mm	M20 x 2.5	M58 x 1.5
Grease Cartridge Adapter 400 g	4522302		400 g	Thread	41 mm	R1"	M58 x 1.5

- 2 speed levels**
max. 295 ml/min
max. 690 bar
- Adjustment dial**
precise control of grease quantity
- Continuous operation locking switch**
- Hose**
120 cm long holder
- Overload protection**
Prevents damage from overheating



**PROFESSIONAL
CORDLESS ANGLE GRINDER 230 MM**
TP-AG 36/230-24 Li Brushless

NEW



BRUSHLESS

PXC battery voltage	2x 18 V
Cable equivalence class	2400 W
Idle speed	6600 min ⁻¹
Wheel diameter	230 mm
Max. cutting depth	70 mm
Product weight	4.2 kg (excl. batteries)
Number of batteries / chargers included in the scope of delivery	0 pcs / 0 pcs
Accessories	Face spanner, cutting wheel guard
Packaging	Colour box
Article number	4431210



2x 18 V

Cutting through pieces of round steel with 12 mm – max. quantity per battery charge

2.0 Ah	2.5 Ah	3.0 Ah	4.0 Ah	5.2 Ah	6.0 Ah	8.0 Ah
50 pcs	62 pcs	74 pcs	99 pcs	129 pcs	148 pcs	198 pcs

Cutting/grinding discs not included

- Enhanced safety**
restart protection
soft-start feature
- High Power**
up to 2,400 W
- Dust screen**
removable for cleaning
- Rotating handle**
enables working in various positions
- 70 mm cutting depth**
with Ø 230 mm cutting discs



**PROFESSIONAL
CORDLESS ANGLE GRINDER 230 MM**
TP-AG 36/230-22 Li Brushless

NEW



BRUSHLESS

PXC battery voltage	2x 18 V
Cable equivalence class	2200 W
Idle speed	6600 min ⁻¹
Wheel diameter	230 mm
Max. cutting depth	70 mm
Product weight	4.0 kg (excl. batteries)
Number of batteries / chargers included in the scope of delivery	0 pcs / 0 pcs
Accessories	Face spanner, cutting wheel guard
Packaging	Colour box
Article number	4431161



2x 18 V

Cutting through pieces of round steel with 12 mm – max. quantity per battery charge

2.0 Ah	2.5 Ah	3.0 Ah	4.0 Ah	5.2 Ah	6.0 Ah	8.0 Ah
32 pcs	41 pcs	48 pcs	62 pcs	81 pcs	93 pcs	124 pcs

Cutting/grinding discs not included

Angle Grinder (230 mm) Accessory

Type	Article number	EAN
TS 230/1 Cutting Stand	4431051	4 006825 632743

- Brushless motor**
durable and powerful
- High power**
36 V battery power up to 2200 W
- Disc guard**
adjustable without tools
- Rotating handle**
enables working in various positions
- 70 mm cutting depth**
with Ø 230 mm cutting discs

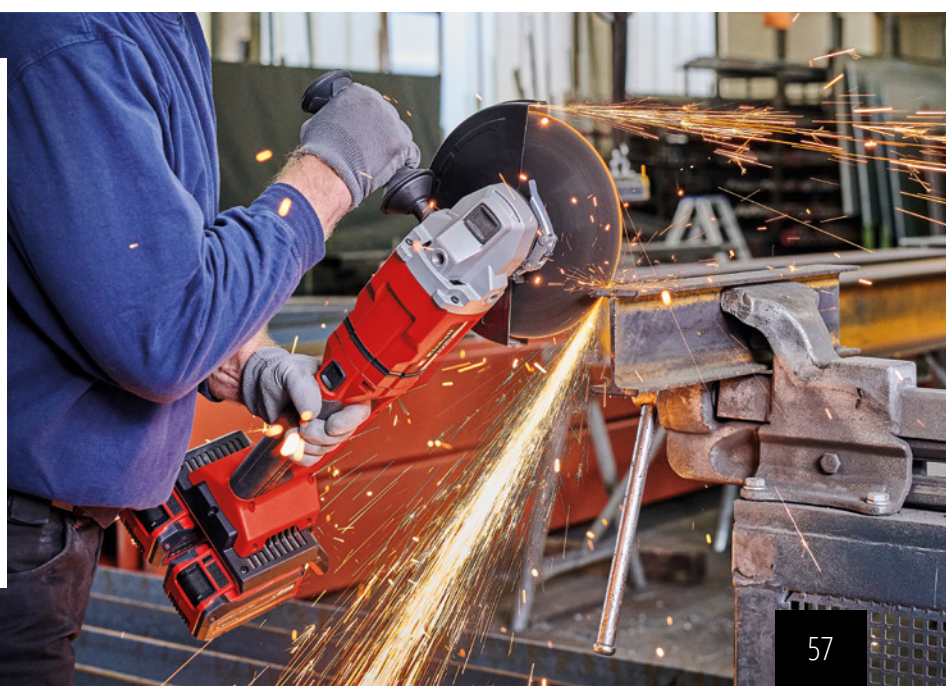

**PROFESSIONAL
CORDLESS ANGLE GRINDER 150 MM
AXXIO 18/150**



BRUSHLESS

PXC battery voltage	18 V
Cable equivalence class	700 W
Idle speed	8500 min ⁻¹
Wheel diameter	150 mm
Max. cutting depth	40 mm
Product weight	1.5 kg (excl. battery)
Number of batteries / chargers included in the scope of delivery	0 pcs / 0 pcs
Accessories	1 cutting wheel, cutting wheel guard, face spanner
Packaging	Colour box
Article number	4431144

Accessories incl.



1x 18 V

Cutting through pieces of round steel with 12 mm – max. quantity per battery charge

2.0 Ah	2.5 Ah	3.0 Ah	4.0 Ah	5.2 Ah	6.0 Ah	8.0 Ah
33 pcs	37 pcs	46 pcs	61 pcs	85 pcs	92 pcs	122 pcs



**PROFESSIONAL
CORDLESS ANGLE GRINDER 125 MM**
TP-AG 18/125-13 Q P Brushless

NEW



BRUSHLESS

PXC battery voltage	18 V
Cable equivalence class	1300 W
Idle speed	10000 min ⁻¹
Wheel diameter	125 mm
Max. cutting depth	33 mm
Product weight	2.1 kg (excl. battery)
Number of batteries / chargers included in the scope of delivery	0 pcs / 0 pcs
Accessories	Quick fix nut, cutting wheel guard
Packaging	Colour box
Article number	4431197



Accessories incl.



1x 18 V

Cutting through pieces of round steel with 12 mm – max. quantity per battery charge

2.0 Ah	2.5 Ah	3.0 Ah	4.0 Ah	5.2 Ah	6.0 Ah	8.0 Ah
36 pcs	45 pcs	54 pcs	71 pcs	93 pcs	107 pcs	142 pcs



**PROFESSIONAL
CORDLESS ANGLE GRINDER 125 MM**
TP-AG 18/125-13 Q Li Brushless

NEW



BRUSHLESS

PXC battery voltage	18 V
Cable equivalence class	1300 W
Idle speed	10000 min ⁻¹
Wheel diameter	125 mm
Max. cutting depth	33 mm
Product weight	2.1 kg (excl. battery)
Number of batteries / chargers included in the scope of delivery	0 pcs / 0 pcs
Accessories	Quick fix nut, cutting wheel guard
Packaging	Colour box
Article number	4431215



Accessories incl.



1x 18 V

Cutting through pieces of round steel with 12 mm – max. quantity per battery charge

2.0 Ah	2.5 Ah	3.0 Ah	4.0 Ah	5.2 Ah	6.0 Ah	8.0 Ah
36 pcs	45 pcs	54 pcs	71 pcs	93 pcs	107 pcs	142 pcs



**PROFESSIONAL
CORDLESS ANGLE GRINDER 125 MM
TP-AG 18/125-11 Q Li Brushless**

NEW



BRUSHLESS

PXC battery voltage	18 V
Cable equivalence class	1100 W
Idle speed	9500 min ⁻¹
Wheel diameter	125 mm
Max. cutting depth	33 mm
Product weight	2.0 kg (excl. battery)
Number of batteries / chargers included in the scope of delivery	0 pcs / 0 pcs
Accessories	Quick fix nut, cutting wheel guard
Packaging	Colour box
Article number	4431220



1x 18 V

Cutting through pieces of round steel with 12 mm – max. quantity per battery charge

2.0 Ah	2.5 Ah	3.0 Ah	4.0 Ah	5.2 Ah	6.0 Ah	8.0 Ah
37 pcs	46 pcs	55 pcs	73 pcs	95 pcs	110 pcs	146 pcs

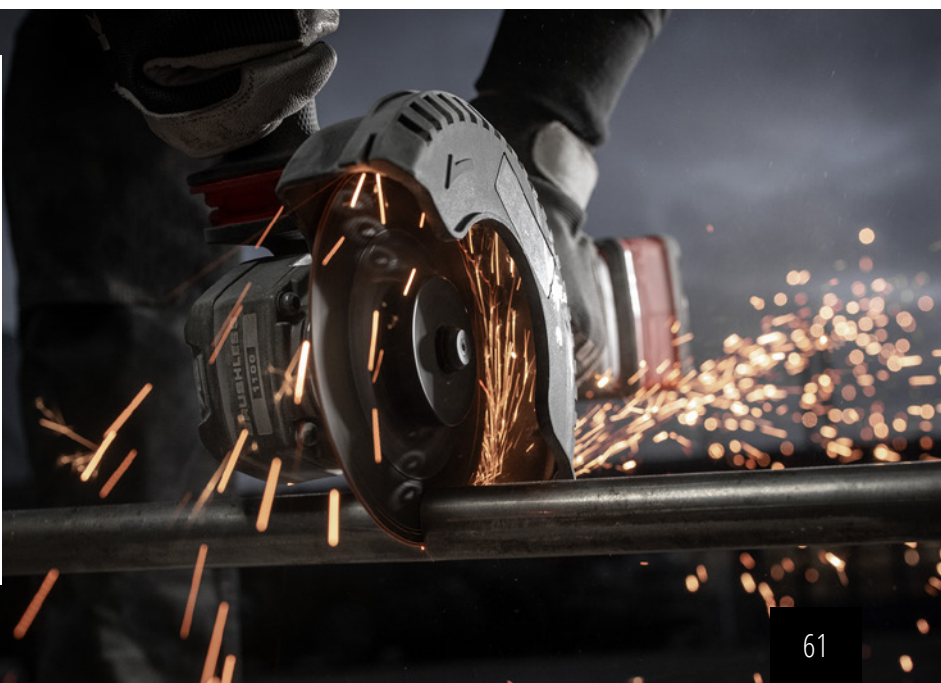

**PROFESSIONAL CORDLESS
FLAT-HEAD ANGLE GRINDER 125 MM**
TP-AG 18/125 F Li Brushless



BRUSHLESS

PXC battery voltage	18 V
Cable equivalence class	700 W
Idle speed	8500 min ⁻¹
Wheel diameter	125 mm
Max. cutting depth	33 mm
Product weight	1.6 kg (excl. battery)
Number of batteries / chargers included in the scope of delivery	0 pcs / 0 pcs
Accessories	Flap disc (curved, ceramics), face spanner, cutting wheel guard
Packaging	Colour box
Article number	4431175 



1x 18 V

Cutting through pieces of round steel with 12 mm – max. quantity per battery charge

2.0 Ah 33 pcs	2.5 Ah 42 pcs	3.0 Ah 50 pcs	4.0 Ah 66 pcs	5.2 Ah 86 pcs	6.0 Ah 99 pcs	8.0 Ah 132 pcs
-------------------------	-------------------------	-------------------------	-------------------------	-------------------------	-------------------------	--------------------------

Angle Grinder (125 mm) Accessory

Type	Article number	EAN
Sanding Mops/Sanding Plates Set – curved, ceramic grain	4440020	



**PROFESSIONAL
CORDLESS ANGLE GRINDER 125 MM
TP-AG 18/125 CE Q Li**



BRUSHLESS

PXC battery voltage	18 V
Cable equivalence class	900 W
Idle speed	3000 - 10500 min ⁻¹
Wheel diameter	125 mm
Max. cutting depth	33 mm
Product weight	1.7 kg (excl. battery)
Number of batteries / chargers included in the scope of delivery	0 pcs / 0 pcs
Accessories	Quick fix nut, cutting wheel guard
Packaging	Colour box
Article number	4431155



Accessories incl.



1x 18 V

Cutting through pieces of round steel with 12 mm – max. quantity per battery charge

2.0 Ah	2.5 Ah	3.0 Ah	4.0 Ah	5.2 Ah	6.0 Ah	8.0 Ah
38 pcs	48 pcs	57 pcs	76 pcs	98 pcs	113 pcs	151 pcs

Cutting/grinding discs not included

- High Power** up to 900 W
- Speed control** with LED display
- Brushless motor** powerful and durable
- Disc guard** adjustable without tools
- Quick-Fix nut** tool-free disc changes
- 33 mm cutting depth** with Ø 125 mm cutting discs



**PROFESSIONAL
CORDLESS ANGLE GRINDER 125 MM
AXXIO 18/125 Q**



BRUSHLESS

Accessories incl.



PXC battery voltage	18 V
Cable equivalence class	700 W
Idle speed	8500 min ⁻¹
Wheel diameter	125 mm
Max. cutting depth	33 mm
Product weight	1.4 kg (excl. battery)
Number of batteries / chargers included in the scope of delivery	0 pcs / 0 pcs
Accessories	Quick fix nut, cutting wheel guard
Packaging	Colour box
Article number	4431151 

**PROFESSIONAL
CORDLESS ANGLE GRINDER 125 MM
AXXIO 18/125**

Same as previous item, but with face spanner instead of a quick fix nut

Number of batteries / chargers included in the scope of delivery	0 pcs / 0 pcs
Accessories	Face spanner, cutting wheel guard
Packaging	Colour box
Article number	4431140 



1x 18 V

Cutting through pieces of round steel with 12 mm – max. quantity per battery charge

2.0 Ah 36 pcs	2.5 Ah 45 pcs	3.0 Ah 54 pcs	4.0 Ah 72 pcs	5.2 Ah 94 pcs	6.0 Ah 108 pcs	8.0 Ah 144 pcs
-------------------------	-------------------------	-------------------------	-------------------------	-------------------------	--------------------------	--------------------------

Cutting/grinding discs not included

Angle Grinder (125 mm) Accessory

Type	Article number	EAN
Quick Fix Nut, M14	49717705	
Sanding Mops/Sanding Plates Set – curved, ceramic grain	4440020	
TS 115/125 Cutting Stand	4431044	



**PROFESSIONAL
CORDLESS ANGLE GRINDER 115 MM
AXXIO 18/115 Q**



BRUSHLESS



PXC battery voltage	18 V
Cable equivalence class	700 W
Idle speed	8500 min ⁻¹
Wheel diameter	115 mm
Max. cutting depth	28 mm
Product weight	1.2 kg (excl. battery)
Number of batteries / chargers included in the scope of delivery	0 pcs / 0 pcs
Accessories	Quick fix nut, cutting wheel guard
Packaging	Colour box
Article number	4431150 

**PROFESSIONAL
CORDLESS ANGLE GRINDER 115 MM
AXXIO 18/115**

Same as previous item, but with face spanner instead of a quick fix nut

Number of batteries / chargers included in the scope of delivery	0 pcs / 0 pcs
Accessories	Face spanner, cutting wheel guard
Packaging	Colour box
Article number	4431154 



1x 18 V

Cutting through pieces of round steel with 12 mm – max. quantity per battery charge

2.0 Ah	2.5 Ah	3.0 Ah	4.0 Ah	5.2 Ah	6.0 Ah	8.0 Ah
36 pcs	45 pcs	54 pcs	72 pcs	94 pcs	108 pcs	144 pcs

Cutting/grinding discs not included

Angle Grinder (125 mm) Accessory

Type	Article number	EAN
Quick Fix Nut, M14	49717705	
TS 115/125 Cutting Stand	4431044	



PROFESSIONAL CORDLESS WALL LINER TP-MA 36/30 Li Brushless



BRUSHLESS

PXC battery voltage	2x 18 V
Cable equivalence class	1500 W
Idle speed	5400 min ⁻¹
Cutting wheel	Ø 125 x Ø 22.2 mm
Channel depth	5 - 30 mm
Channel width	8 - 30 mm
Product weight	4.3 kg (excl. battery)
Number of batteries / chargers included in the scope of delivery	0 pcs / 0 pcs
Diamond cutting wheel	2 pcs
Storage case	•
Packaging	Colour box
Article number	4350800 

Accessories incl.



2x 18 V

Brick stone 15 mm - max. cutting capacity per battery charge

2.0 Ah	2.5 Ah	3.0 Ah	4.0 Ah	5.2 Ah	6.0 Ah	8.0 Ah
10 m	13 m	15 m	20 m	26 m	30 m	40 m

Matching accessories

Diamond Cutting Wheels Set 125 mm 4350736



PROFESSIONAL CORDLESS ROUTER TP-RO 18/55 Li Brushless

NEW

PXC battery voltage	18 V
Idle speed	10000 - 30000 min ⁻¹
Stroke height	55 mm
Max. form cutter	30 mm
Product weight	2.5 kg (excl. battery)
Number of batteries / chargers included in the scope of delivery	0 pcs / 0 pcs
Parallel stop	•
Compass point	•
Clamp diameter	6 mm / 8 mm
Packaging	Colour box
Article number	4350425 



1x 18 V

Grooving in soft wood (depth: 3 mm, milling cutter Ø 6 mm), max. length per battery charge

2.0 Ah	2.5 Ah	3.0 Ah	4.0 Ah	5.2 Ah	6.0 Ah	8.0 Ah
29 m	37 m	44 m	58 m	77 m	88 m	118 m



Matching accessories

Router Guide Rail Adapter	4350420 
Guide Bar Aluminium 2x 1000 mm	4502118 

Accessories incl.

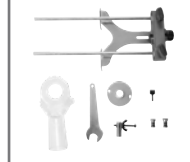

BRUSHLESS

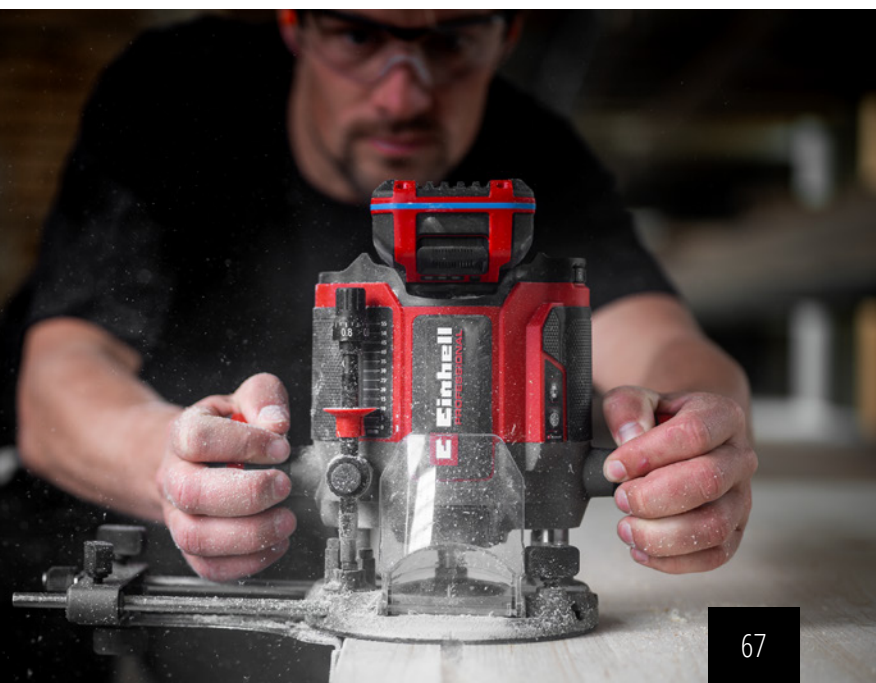
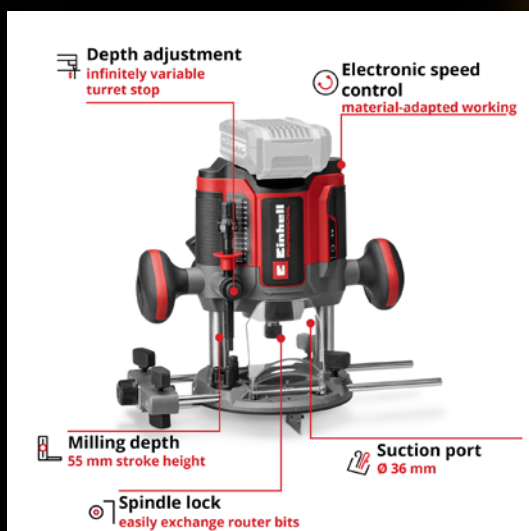

PROFESSIONAL CORDLESS ROUTER TP-RO 18 Set Li Brushless



PXC battery voltage	18 V
Idle speed	10000 - 30000 min ⁻¹
Stroke height	40 mm / 35 mm
Max. form cutter	30 mm
Product weight	1.3 kg (palm router) / 2.4 kg (two-handed router) – each excl. battery
Number of batteries / chargers included in the scope of delivery	0 pcs / 0 pcs
Parallel stop	•
Compass point	•
Attachment	Two-handed attachment + edge trimmer base
Clamp diameter	6 mm / 8 mm
Packaging	Colour box
Article number	4350410 

BRUSHLESS

1x 18 V



Grooving in soft wood (depth: 3 mm, milling cutter Ø 6 mm), max. length per battery charge

2.0 Ah	2.5 Ah	3.0 Ah	4.0 Ah	5.2 Ah	6.0 Ah	8.0 Ah
29 m	37 m	44 m	58 m	77 m	88 m	118 m

Accessories incl.



Matching accessories

Router Guide Rail Adapter	4350420	
Guide Bar Aluminium 2x 1000 mm	4502118	



PROFESSIONAL CORDLESS ROUTER TP-RO 18 Li Brushless

PXC battery voltage	18 V
Idle speed	10000 - 30000 min ⁻¹
Stroke height	35 mm
Max. form cutter	30 mm
Product weight	2.4 kg (excl. battery)
Number of batteries / chargers included in the scope of delivery	0 pcs / 0 pcs
Parallel stop	•
Compass point	•
Attachment	Two-handed attachment
Clamp diameter	6 mm / 8 mm
Packaging	Colour box
Article number	4350411



1x 18 V

Grooving in soft wood (depth: 3 mm, milling cutter Ø 6 mm), max. length per battery charge

2.0 Ah	2.5 Ah	3.0 Ah	4.0 Ah	5.2 Ah	6.0 Ah	8.0 Ah
29 m	37 m	44 m	58 m	77 m	88 m	118 m



BRUSHLESS

Matching accessories

Router Guide Rail Adapter	4350420	
Guide Bar Aluminium 2x 1000 mm	4502118	

Accessories incl.



- Speed control electronics**
adapts the tool to the material at hand
- Brushless motor**
powerful and durable
- Depth adjustment**
infinitely variable
turret stop
- Suction port**
Ø 36 mm
- Spindle lock**
easily exchange router



PROFESSIONAL CORDLESS PALM ROUTER TP-ET 18 Li Brushless

PXC battery voltage	18 V
Idle speed	10000 - 30000 min ⁻¹
Stroke height	40 mm
Max. form cutter	30 mm
Product weight	1.3 kg (excl. battery)
Number of batteries / chargers included in the scope of delivery	0 pcs / 0 pcs
Parallel stop	•
Compass point	•
Attachment	Edge trimmer base
Clamp diameter	6 mm / 8 mm
Packaging	Colour box
Article number	4350412



Accessories incl.



BRUSHLESS

1x 18 V

Grooving in soft wood (depth: 3 mm, milling cutter Ø 6 mm), max. length per battery charge

2.0 Ah	2.5 Ah	3.0 Ah	4.0 Ah	5.2 Ah	6.0 Ah	8.0 Ah
29 m	37 m	44 m	58 m	77 m	88 m	118 m



PROFESSIONAL CORDLESS PLANER TP-PL 18/3 Li Brushless



BRUSHLESS

PXC battery voltage	18 V
Idle speed	12000 min ⁻¹
Planing width	82 mm
Chip depth	3 mm
Rebate depth	25 mm
Product weight	2.6 kg (excl. battery)
Number of batteries / chargers included in the scope of delivery	0 pcs / 0 pcs
Parallel stop	•
Rebate depth stop	•
Planing blades (reversible blades)	2 pcs TCT
Packaging	Colour box
Article number	4345405



Accessories incl.

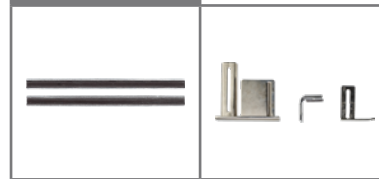

1x 18 V

Planing of spruce wood (depth: 1 mm / width: 50 mm), maximum length per battery charge

2.0 Ah	2.5 Ah	3.0 Ah	4.0 Ah	5.2 Ah	6.0 Ah	8.0 Ah
26 m	32 m	38 m	50 m	65 m	78 m	100 m

Matching accessories

Blade Set	49568315
-----------	----------



PROFESSIONAL CORDLESS JIGSAW TP-JS 18/135 Li Brushless

PXC battery voltage	18 V	
Stroke speed	0 - 3500 min ⁻¹	
Cutting depth (wood / plastic / steel / aluminium)	135 / 20 / 10 / 20 mm	
Product weight	2.1 kg (excl. battery)	
Number of batteries / chargers included in the scope of delivery	0 pcs / 0 pcs	
Accessories	1 saw blade (wood), parallel stop, chip guard	
Packaging	Colour box	
Article number	4321260	

1x 18 V



19 mm chipboard – max. cutting capacity per battery charge

2.0 Ah	2.5 Ah	3.0 Ah	4.0 Ah	5.2 Ah	6.0 Ah	8.0 Ah
14 m	18 m	21 m	29 m	37 m	43 m	57 m



BRUSHLESS

Matching accessories

Jigsaw Blade Set, 10-piece	49617350	
Jigsaw Blade Set, 4-piece	49625427	



- Electronic speed control**
material-specific sawing
- Brushless Motor**
powerful and durable
- Dust extraction**
at 90° angle
optimised hose position
- Blade exchange**
easy and toolless
- Pendulum stroke**
26 mm stroke height
135 mm cutting depth in wood



PROFESSIONAL CORDLESS JIGSAW TP-JST 18/135 Li Brushless



BRUSHLESS

PXC battery voltage	18 V
Stroke speed	0 - 3500 min ⁻¹
Cutting depth (wood / plastic / steel / aluminium)	135 / 20 / 10 / 20 mm
Product weight	2.0 kg (excl. battery)
Number of batteries / chargers included in the scope of delivery	0 pcs / 0 pcs
Accessories	3 saw blades (wood), parallel stop, chip guard
Packaging	Colour box
Article number	4321265 

Accessories incl.





1x 18 V

19 mm chipboard - max. cutting capacity per battery charge

2.0 Ah	2.5 Ah	3.0 Ah	4.0 Ah	5.2 Ah	6.0 Ah	8.0 Ah
14 m	18 m	21 m	29 m	37 m	43 m	57 m

Matching accessories

Jigsaw Blade Set, 10-piece	49617350	
Jigsaw Blade Set, 4-piece	49625427	

- Brushless motor**
durable and powerful
- Speed electronics**
material-specific sawing
- Continuous running lock**
ergonomic working
- Dust extraction**
at 90° angle
optimal hose position
- Saw blade change**
simple and tool-free
- Pendulum lifting function**
26 mm lifting height
135 mm cutting depth in wood

PROFESSIONAL CORDLESS CIRCULAR SAW TP-CS 18/190 Li Brushless



BRUSHLESS

PXC battery voltage	18 V
Cable equivalence class	600 W
Idle speed	3800 min ⁻¹
Saw blade	Ø 190 x Ø 20/30 mm
Cutting depth 90°	65 mm
Cutting depth 45°	45 mm
Product weight	3.2 kg (excl. battery)
Number of batteries / chargers included in the scope of delivery	0 pcs / 0 pcs
Accessories	Parallel stop
Packaging	Colour box
Article number	4331210



1x 18 V

19 mm chipboard – max. cutting capacity per battery charge

2.0 Ah	2.5 Ah	3.0 Ah	4.0 Ah	5.2 Ah	6.0 Ah	8.0 Ah
24 m	30 m	37 m	49 m	63 m	73 m	98 m

Matching accessories

Saw blade for woodworking, TCT, Ø 190 x Ø 30 x 2.0 mm, t30	49586956	4 009315 869568
Guide Bar Aluminium 2x 1000 mm	4502118	4 006825 632675

- Brushless motor**
durable and powerful
- Clean work**
36 mm suction connection
- LED light**
illumination of the cutting area
- Large saw blade**
190 mm diameter
- Spindle lock**
easy blade change
- Tool-free adjustment**
cutting depths up to 65 mm tilting angle



PROFESSIONAL CORDLESS CIRCULAR SAW TP-CS 18/165 Li Brushless



BRUSHLESS



PXC battery voltage	18 V
Idle speed	5000 min ⁻¹
Saw blade	Ø 165 x 16/20 mm
Cutting depth 90°	59 mm
Cutting depth 45°	44 mm
Product weight	2.9 kg (excl. battery)
Number of batteries / chargers included in the scope of delivery	0 pcs / 0 pcs
Accessories	Parallel stop
Packaging	Colour box
Article number	4331225 

1x 18 V

19 mm chipboard – max. cutting capacity per battery charge

2.0 Ah	2.5 Ah	3.0 Ah	4.0 Ah	5.2 Ah	6.0 Ah	8.0 Ah
19 m	24 m	29 m	38 m	49 m	57 m	75 m

Matching accessories

Saw Blade for Woodworking, TCT, Ø 165 x Ø 20 x 1.8 mm, t24	4502076	
Guide Bar Aluminium 2x 1000 mm	4502118	



**PROFESSIONAL
CORDLESS PLUNGE CUT SAW**
TP-PS 18/165 Li Brushless



BRUSHLESS

PXC battery voltage	18 V
Idle speed	5000 min ⁻¹
Saw blade	Ø 165 x 20 mm
Cutting depth 90°	56 mm
Cutting depth 45°	42 mm
Product weight	4.1 kg (excl. battery)
Number of batteries / chargers included in the scope of delivery	0 pcs / 0 pcs
Accessories	Parallel stop
Packaging	Colour box
Article number	4331400





1x 18 V

19 mm chipboard – max. cutting capacity per battery charge

2.0 Ah	2.5 Ah	3.0 Ah	4.0 Ah	5.2 Ah	6.0 Ah	8.0 Ah
19 m	24 m	29 m	39 m	51 m	59 m	79 m

Matching accessories

Guide Bar Aluminium 2x 1000 mm	4502118	 4 006825 632675
Saw blade for woodworking, TCT Ø 165 x Ø 20 x 1.8 mm, t56	4502078	 4 006825 687002



PROFESSIONAL CORDLESS ALL PURPOSE SAW TP-AP 18/32 Li Brushless



PXC battery voltage	18 V
Cable equivalence class	1300 W
Stroke speed	0 - 3000 min ⁻¹
Stroke height	32 mm
Cutting depth (wood / steel)	300 / 20 mm
Saw blade thickness	0.8 - 1.7 mm
Product weight	3.4 kg (excl. battery)
Number of batteries / chargers included in the scope of delivery	0 pcs / 0 pcs
Accessories	1 saw blade (wood) + 1 saw blade (metal)
Packaging	Colour box
Article number	4326295



BRUSHLESS

1x 18 V

Round timber 35 mm – max. number of cuts per battery charge

2.0 Ah	2.5 Ah	3.0 Ah	4.0 Ah	5.2 Ah	6.0 Ah	8.0 Ah
221 pcs	276 pcs	331 pcs	441 pcs	573 pcs	661 pcs	881 pcs

Accessories incl.



Matching accessories

All Purpose Saw Blades Set 3-piece	49576105
------------------------------------	----------



- High power**
max. 1,300 W
- Electronic speed control**
material-adapted sawing
- Pendulum stroke**
separate activation
- Blade exchange**
easy and toolless
- Precise cuts**
up to 300 mm deep in wood
32 mm stroke height



**PROFESSIONAL
CORDLESS ALL PURPOSE SAW**
TP-AP 18/28 Li Brushless



PXC battery voltage	18 V
Cable equivalence class	950 W
Stroke speed	0 - 2500 min ⁻¹
Stroke height	28 mm
Cutting depth (wood / steel)	200 / 12 mm
Saw blade thickness	0.9 - 1.6 mm
Product weight	2.0 kg (excl. battery)
Number of batteries / chargers included in the scope of delivery	0 pcs / 0 pcs
Accessories	1 saw blade (wood)
Packaging	Colour box
Article number	4326310



BRUSHLESS

1x 18 V

Round timber 35 mm – max. number of cuts per battery charge

2.0 Ah 226 pcs	2.5 Ah 332 pcs	3.0 Ah 417 pcs	4.0 Ah 556 pcs	5.2 Ah 723 pcs	6.0 Ah 834 pcs	8.0 Ah 1112 pcs
--------------------------	--------------------------	--------------------------	--------------------------	--------------------------	--------------------------	---------------------------

Matching accessories

All Purpose Saw Blades Set 3-piece	49576105
------------------------------------	----------



- Brushless motor**
durable and powerful
- High power**
max. 950 W
- Saw shoe**
adjustable without tools
- Saw blade change**
simple and tool-free
- Precise cuts**
up to 200 mm deep in wood
28 mm lifting height
- Speed control**
easily adjustable



PROFESSIONAL CORDLESS MULTIFUNCTIONAL TOOL TP-MG 18/3.6 Li Brushless



BRUSHLESS

PXC battery voltage	18 V
Idle speed	11000 - 20000 min ⁻¹
Oscillation angle	3.6°
Abrasive paper size	93 x 93 x 93 mm
Product weight	1.1 kg (excl. battery)
Number of batteries / chargers included in the scope of delivery	0 pcs / 0 pcs
Delta grinding/sanding disc	•
Abrasive paper	3x P60, 3x P80, 3x P120
Scraper	•
Plunge-cut blades	1 pc wood/plastic, 1 pc metal
Segment saw blades	1 pc wood/plastic/non-ferrous metal, 1pc tile joints
Suction adapter	•
Packaging	E-Case
Article number	4465192 

Accessories incl.



1x 18 V

Max. operating time per battery charge in idle mode

2.0 Ah	2.5 Ah	3.0 Ah	4.0 Ah	5.2 Ah	6.0 Ah	8.0 Ah
34 min	43 min	51 min	68 min	89 min	102 min	136 min

Round plastics 10 mm – max. number of cuts per battery charge

680 pcs	850 pcs	1020 pcs	1356 pcs	1770 pcs	2035 pcs	2715 pcs
---------	---------	----------	----------	----------	----------	----------

Round steel 6 mm – max. number of cuts per battery charge

144 pcs	180 pcs	216 pcs	288 pcs	375 pcs	432 pcs	576 pcs
---------	---------	---------	---------	---------	---------	---------



PROFESSIONAL CORDLESS MULTIFUNCTIONAL TOOL TP-MG 18 Li Brushless



BRUSHLESS

PXC battery voltage	18 V
Idle speed	11000 - 20000 min ⁻¹
Oscillation angle	3.2°
Abrasive paper size	93 x 93 x 93 mm
Product weight	1.1 kg (excl. battery)
Number of batteries / chargers included in the scope of delivery	0 pcs / 0 pcs
Delta grinding/sanding disc	•
Abrasive paper	3x P60, 3x P80, 3x P120
Scraper	•
Plunge-cut blades	1 pc wood/plastic, 1 pc metal
Segment saw blades	1 pc wood/plastic/non-ferrous metal, 1 pc tile joints
Packaging	Colour box
Article number	4465190



Accessories incl.



1x 18 V

Max. operating time per battery charge in idle mode

2.0 Ah	2.5 Ah	3.0 Ah	4.0 Ah	5.2 Ah	6.0 Ah	8.0 Ah
34 min	43 min	51 min	68 min	89 min	102 min	136 min

Round plastics 10 mm – max. number of cuts per battery charge

680 pcs	850 pcs	1020 pcs	1356 pcs	1770 pcs	2035 pcs	2715 pcs
---------	---------	----------	----------	----------	----------	----------

Round steel 6 mm – max. number of cuts per battery charge

144 pcs	180 pcs	216 pcs	288 pcs	375 pcs	432 pcs	576 pcs
---------	---------	---------	---------	---------	---------	---------



PROFESSIONAL CORDLESS DRYWALL POLISHER TP-DWS 18/225 Li Brushless



BRUSHLESS

PXC battery voltage	18 V
Idle speed	600 - 1200 min ⁻¹
Abrasive paper dimensions, Ø	225 mm
Hose length	1.3 - 4.5 m
Product weight	2.4 kg (excl. battery)
Number of batteries / chargers included in the scope of delivery	0 pcs / 0 pcs
Abrasive paper	2x P60, 2x P80, 2x P120 + abrasive mesh P120
Dust bag	•
Packaging	Colour box
Article number	4259995



1x 18 V

Max. operating time per battery charge in idle mode

2.0 Ah	2.5 Ah	3.0 Ah	4.0 Ah	5.2 Ah	6.0 Ah	8.0 Ah
24 min	29 min	35 min	47 min	61 min	70 min	93 min



- Brushless motor**
durable and powerful
- Speed electronics**
with LED display
- Additional handle**
adjustable
- Brush ring**
removable
- Integrated dust extraction**
dust collection bag
- Fixable sanding plate**
for sanding wood, for example



PROFESSIONAL CORDLESS DRYWALL POLISHER TP-DW 18/225 Li

PXC battery voltage	18 V
Idle speed	600 - 1200 min ⁻¹
Abrasive paper dimensions, Ø	225 mm
Device length	110 - 165 cm
Hose length	1.3 - 4.5 m
Product weight	3.6 kg (excl. battery)
Number of batteries / chargers included in the scope of delivery	0 pcs / 0 pcs
Abrasive paper	2x P60, 2x P80, 2x P120 + abrasive mesh P120
Dust bag	•
Packaging	E-Box
Article number	4259990 

1x 18 V

Max. operating time per battery charge in idle mode

2.0 Ah	2.5 Ah	3.0 Ah	4.0 Ah	5.2 Ah	6.0 Ah	8.0 Ah
26 min	33 min	44 min	55 min	68 min	78 min	110 min



Accessories incl.

Drywall Polishers Accessories

Type	Article number	EAN	Items supplied	Set includes
Abrasive Mesh Set	49491006		5-piece	Universal abrasive mesh Ø 225 mm (3x 80 grit, 2x 120 grit)
Abrasive Mesh / Grinding/Sanding Wheel Set	49491066		15-piece	Universal abrasive mesh Ø 225 mm (4x 80 grit / 2x 120 grit for filling compound and acrylic lacquer); corundum grinding/sanding wheels, white (4x 80 grit / 2x 120 grit for lacquer, hardwood / softwood); corundum grinding/sanding wheels, red (2x 80 grit / 1x 120 grit for wood, metal, plastics)



PROFESSIONAL CORDLESS BRUSH SANDER TP-BR 18/32 Li Brushless

PXC battery voltage	18 V	
Cable equivalence class	1300 W	
Idle speed	900 - 3200 min ⁻¹	
Grinding brush Ø	120 mm	
Grinding brush width	100 mm	
Product weight	2.3 kg (excl. battery)	
Number of batteries / chargers included in the scope of delivery	0 pcs / 0 pcs	
Incl. brass wire brush	•	
Packaging	Colour box	
Article number	4468000	 4 006825 679380



BRUSHLESS

1x 18 V

Sanding of softwood beams (10 cm) at max. speed – max. operating time per battery charge

2.0 Ah	2.5 Ah	3.0 Ah	4.0 Ah	5.2 Ah	6.0 Ah	8.0 Ah
11 min	13 min	16 min	21 min	27 min	32 min	42 min

Cordless Brush Sanders Accessories

Type	Article number	EAN	Ø	Width	Grit size	Can be used for
 Synthetic Fibre Brush	4468010	 4 006825 681796	120 mm	100 mm	P80	Wood and metal
 Nylon Brush	4468011	 4 006825 681802	120 mm	100 mm	-	Wood, metal and stone
 Abrasive Strip Brush	4468012	 4 006825 681819	120 mm	100 mm	P80	Wood and metal
 Sanding Strip Brush	4468013	 4 006825 681826	120 mm	100 mm	P80	Wood and metal
 Brass Wire Brush	4468014	 4 006825 681833	120 mm	100 mm	-	Wood, metal and robust stone

- High power**
up to 1300 W
- Electronic speed control**
material-adapted grinding
- Brushless motor**
powerful and durable
- Brush**
100 mm wide
Ø 120 mm
- Brush guard incl. additional handle**
adjustable



PROFESSIONAL CORDLESS BAND SANDER TP-BS 18/457 Li Brushless



PXC battery voltage	18 V
Grinding/sanding belt speed	120 - 250 m/min
Grinding/sanding area	75 x 126 mm
Grinding/sanding belt size	75 x 457 mm
Product weight	2.5 kg (excl. battery)
Number of batteries / chargers included in the scope of delivery	0 pcs / 0 pcs
Sanding/grinding belt	3x P80
Dust collection box	•
Packaging	Colour box
Article number	4466270 

Accessories incl.



BRUSHLESS

1x 18 V

Max. operating time per battery charge in idle mode

2.0 Ah	2.5 Ah	3.0 Ah	4.0 Ah	5.2 Ah	6.0 Ah	8.0 Ah
15 min	18 min	22 min	30 min	38 min	44 min	59 min

Matching accessories

Grinding Belt Set, 6-piece (60 grit, 80 grit, 120 grit – 2 of each), for wood and metal	4419815	
---	---------	---

- Speed control electronics**
grinding performance tailored to the material
- Trigger lock**
for comfortable operation
- Dust extraction**
suction port
dust collection bag
- Abrasive belt**
max. 250 m/min
457 mm long
- Abrasive surface**
length 126 mm
width 75 mm



PROFESSIONAL CORDLESS ROTATING SANDER TP-RS 18/32 Li Brushless



BRUSHLESS

PXC battery voltage	18 V
Oscillating speed	6000 - 24000 min ⁻¹
Oscillating circuit, Ø	3.2 mm
Abrasive paper, Ø	125 mm
Product weight	1.1 kg (excl. battery)
Number of batteries / chargers included in the scope of delivery	0 pcs / 0 pcs
Abrasive paper	1x P60, 1x P80, 1x P120
Dust collection box	•
Packaging	Colour box
Article number	4462020 

Accessories incl.



1x 18 V

Max. operating time per battery charge in idle mode

2.0 Ah	2.5 Ah	3.0 Ah	4.0 Ah	5.2 Ah	6.0 Ah	8.0 Ah
29 min	36 min	44 min	58 min	75 min	87 min	115 min

Matching accessories

Grinding Belt Set, 25-piece (9x 60 grit, 8x 120 grit, 8x 180 grit), for wood and metal

49491974



**PROFESSIONAL
CORDLESS ECCENTRIC POLISHER**
CP-EP 18/125 Li Brushless

NEW



BRUSHLESS

PXC battery voltage	18 V
Idle speed	500 - 3800 min ⁻¹
Diameter	125 mm
Oscillating circuit	8 mm
Product weight	2.2 kg (excl. battery)
Number of batteries / chargers included in the scope of delivery	0 pcs / 0 pcs
Polishing pads	3 pcs (different hardness levels)
Article number	2093330 

Accessories incl.



1x 18 V

Max. operating time per battery charge in idle mode

2.0 Ah	2.5 Ah	3.0 Ah	4.0 Ah	5.2 Ah	6.0 Ah	8.0 Ah
25 min	30 min	35 min	50 min	65 min	70 min	100 min

Matching accessories

Polishing Pad Set, 3-piece (different hardness levels)	2093247 
--	---



PROFESSIONAL CORDLESS NAILER FIXETTO 18/50 N

PXC battery voltage	18 V
Max. working speed	60 per min
Nail length	15 - 50 mm
Nail thickness	1.0 mm
Product weight	2.8 kg (excl. battery)
Number of batteries / chargers included in the scope of delivery	0 pcs / 0 pcs
Nails	500 pcs - 50 mm
Packaging	Colour box
Article number	4257795 

1x 18 V

Nails (l = 32 mm, w = 1 mm) in softwood – max. number per battery charge





2.0 Ah	2.5 Ah	3.0 Ah	4.0 Ah	5.2 Ah	6.0 Ah	8.0 Ah
840 pcs	1050 pcs	1260 pcs	1679 pcs	2183 pcs	2519 pcs	3358 pcs

Nails (l = 50 mm, w = 1 mm) in softwood – max. number per battery charge

685 pcs	857 pcs	1028 pcs	1370 pcs	1781 pcs	2055 pcs	2740 pcs
---------	---------	----------	----------	----------	----------	----------



Matching accessories

Nails, 3000 pcs (Type J, 1.0 x 50 mm)	4137873	
Nails, 3000 pcs (Type J, 1.0 x 40 mm)	4137872	
Nails, 3000 pcs (Type J, 1.0 x 32 mm)	4137874	
Nails, 3000 pcs (Type J, 1.0 x 25 mm)	4137871	

Accessories incl.



PROFESSIONAL CORDLESS STAPLER FIXETTO 18/40 S

PXC battery voltage	18 V
Max. working speed	60 per min
Staple length	10 - 40 mm
Staple width	5.7 mm
Product weight	2.9 kg (excl. battery)
Number of batteries / chargers included in the scope of delivery	0 pcs / 0 pcs
Staples	500 pcs - 40 mm
Packaging	Colour box
Article number	4257785 



1x 18 V







Stapling (staples: 38 mm) in softwood – max. number per battery charge

2.0 Ah	2.5 Ah	3.0 Ah	4.0 Ah	5.2 Ah	6.0 Ah	8.0 Ah
780 pcs	975 pcs	1170 pcs	1560 pcs	2028 pcs	2340 pcs	3120 pcs

Stapling (staples: 22 mm) in softwood – max. number per battery charge

850 pcs	1063 pcs	1275 pcs	1700 pcs	2210 pcs	2250 pcs	3400 pcs
---------	----------	----------	----------	----------	----------	----------

Matching accessories

Staples, 3000 pcs (Type E, chisel points, 5.7 x 40 mm)	4137861	
Staples, 3000 pcs (Type E, chisel points, 5.7 x 38 mm)	4137876	
Staples, 3000 pcs (Type E, chisel points, 5.7 x 25 mm)	4137860	
Staples, 3000 pcs (Type E, chisel points, 5.7 x 19 mm)	4137875	
Staples, 3000 pcs (Type E, chisel points, 5.7 x 16 mm)	4137855	
Staples, 3000 pcs (Type E, chisel points, 5.7 x 13 mm)	4137850	

Accessories incl.



PROFESSIONAL CORDLESS LIGHT TP-CL 18/3000 Li

PXC battery voltage	18 V	
Luminosity	200 - 3000 lm, infinitely adjustable	
Light source	60 LEDs	
Light ON time	2.5 h (4.0 Ah)	
Product weight	1.7 kg (excl. battery)	
Number of batteries / chargers included in the scope of delivery	0 pcs / 0 pcs	
Packaging	Colour box	
Article number	4514172	 4 006825 672329



1x 18 V

Luminous period per battery charge – 3000 lm

2.0 Ah	2.5 Ah	3.0 Ah	4.0 Ah	5.2 Ah	6.0 Ah	8.0 Ah
73 min	91 min	109 min	145 min	189 min	218 min	291 min



Cordless Lights Accessory

Type	Article number	EAN	Suitable for	Working height	Tilt angle adjustment	Adapter for lights and lasers	Product weight
Tripod 85 - 170 cm	2270116	 4 006825 672572	TP-CL 18/3000 Li, TP-CL 18/3000 Li Set	85 - 170 cm	•	1/4" + 5/8" thread	1.8 kg (incl. adapter)
Tripod 37 - 110 cm	2270115	 4 006825 616255	TP-CL 18/3000 Li, TP-CL 18/3000 Li Set	37 - 110 cm	•	1/4" thread	0.6 kg



PROFESSIONAL CORDLESS LIGHT TP-CL 18/3000 Li Set

PXC battery voltage	18 V
Luminosity	200 - 3000 lm, infinitely adjustable
Light source	60 LEDs
Light ON time	2.5 h (4.0 Ah)
Product weight	3.3 kg (excl. battery)
Number of batteries / chargers included in the scope of delivery	0 pcs / 0 pcs
Tripod 85 - 170 cm	•
Packaging	Colour box
Article number	4514170



1x 18 V

Luminous period per battery charge – 3000 lm

2.0 Ah	2.5 Ah	3.0 Ah	4.0 Ah	5.2 Ah	6.0 Ah	8.0 Ah
73 min	91 min	109 min	145 min	189 min	218 min	291 min

Accessories incl.



TP-CL 18/3000 Li Set Accessory

Type	Article number	EAN	Adapter	Product weight	Packaging
Adapter	2270122	4 006825 679847	5/8" to 1/4"	0.2 kg	Colour box



PROFESSIONAL CORDLESS WET AND DRY VACUUM CLEANER TP-VC 36/30 S Auto

PXC battery voltage	2x 18 V	
Suction power	150 mbar / 100 mbar (BOOST / ECO)	
Tank	Stainless steel, 30 l	
Suction hose length / diameter	250 cm / 36 mm	
Noise level	76 dB(A)	
Product weight	8.1 kg (excl. batteries)	
Number of batteries / chargers included in the scope of delivery	0 pcs / 0 pcs	
Suction tube	Telescopic, stainless steel	
Nozzles	Combi, crevice, upholstery nozzle, power tool adapter (1 of each)	
Filters	Foam, pleated filter, dirt bag (1x each)	
More accessories	Transmitter unit for connectivity, fixing tape and charging cable (1 of each)	
Article number	2347143	



2x 18 V

Max. operating time per battery charge in idle mode (ECO mode)

2.0 Ah	2.5 Ah	3.0 Ah	4.0 Ah	5.2 Ah	6.0 Ah	8.0 Ah
11 min	13 min	16 min	22 min	28 min	33 min	44 min

Max. operating time per battery charge in idle mode (BOOST mode)

8 min	10 min	12 min	16 min	21 min	24 min	32 min
-------	--------	--------	--------	--------	--------	--------

Accessories incl.





- Twin-Pack technology**
36 V battery power
- Connectivity**
automatic dust extraction without cable connection
- ECO/BOOST mode**
optimal battery use
- High suction capacity**
150 mbar
- Collection container**
30 litre capacity stainless steel



PROFESSIONAL CORDLESS WET AND DRY VACUUM CLEANER TP-VC 18/10 Li Brushless L

NEW

PXC battery voltage	18 V
Suction power	180 mbar / 120 mbar (BOOST / ECO)
Tank	Plastic, 10 l
Suction hose length / diameter	180 cm / 36 mm
Noise level	71 dB(A)
Dust class	L
Product weight	3.1 kg (excl. battery)
Number of batteries / chargers included in the scope of delivery	0 pcs / 0 pcs
Suction tube	2-piece, plastic
Nozzles	Wide suction nozzle, crevice nozzle (1 of each)
Filters	Foam filter, pleated filter, fleece bag (1 of each)
More accessories	Carrying strap, inflation adapter (1 of each)
Article number	2347155 



1x 18 V

Max. operating time per battery charge in idle mode (ECO mode)

2.0 Ah	2.5 Ah	3.0 Ah	4.0 Ah	5.2 Ah	6.0 Ah	8.0 Ah
26 min	33 min	40 min	52 min	68 min	80 min	104 min

Max. operating time per battery charge in idle mode (BOOST mode)



9 min	11 min	14 min	18 min	24 min	29 min	36 min
-------	--------	--------	--------	--------	--------	--------

Accessories incl.



BRUSHLESS
E-CASE SYSTEM

Matching accessories

Non-woven Bags, 10 l (set of 5)	2351262	
Pleated Filter for dust class L, 13 cm	2351272	



Cordless Wet and Dry Vacuum Cleaners / Wet and Dry Vacuum Cleaners Accessories

Type	Article number	EAN	Items supplied	For tank volume	Suction hose length / diameter
Pleated Filter for dust class L, 13 cm	2351272	4 006825 684308	1 pc	-	-
Pleated filter	2351110	4 006825 231090	1 pc	-	-
Pleated Filter with Lid	2351113	4 006825 566512	1 pc	-	-
Fabric Filter	2351140	4 006825 231151	1 pc	-	-
Foam Filters	2351132	4 006825 644098	5 pcs	-	-
Foam Filters 10 l	2351135	4 006825 641424	5 pcs	10 l	-
Non-woven Bags 40 l	2351195	4 006825 625691	5 pcs	30 - 50 l	-
Non-woven Bags 10 l	2351262	4 006825 684247	5 pcs	10 l	-
Dirt Bags 30 l	2351170	4 006825 528763	5 pcs	30 l	-
Flexible Crevice Nozzle, long	2351204	4 006825 653953	1 pc	-	-
Floor Nozzle with Rollers	2351216	4 006825 671100	1 pc	-	-
Universal Floor Nozzle	2351215	4 006825 630060	1 pc	-	-
Drilling Nozzle	2351233	4 006825 653960	1 pc	-	-
Round Carpet Brush	2351230	4 006825 630091	1 pc	-	-
Set of Nozzles	2351235	4 006825 630107	2 nozzles, 1 brush	-	-
Car Cleaning Set	2351245	4 006825 630121	7-piece set	-	300 cm / 36 mm
Premium Suction Hose	2362005	4 006825 651980	1 heavy-duty suction hose, 3 adapters	-	300 cm / 36 mm
Suction Hose	2362000	4 006825 543018	1 hose, 3 adapters	-	300 cm / 36 mm
Suction Hose Extension	2351270	4 006825 670592	1 hose	-	300 cm / 36 mm

Assignment of Accessories to Wet and Dry Vacuum Cleaners

		2351272	2351110	2351113	2351140	2351132	2351135	2351195	2351262	2351170	2351204	2351216	2351215	2351233	2351230	2351235	2351245	2362005	2362000	2351270	
	Pleated Filter for dust class L, 13 cm		•																		
	Pleated Filter		•																		
	Pleated Filter with Lid		•																		
	Fabric Filter		•																		
	Foam Filters		•																		
	Foam Filter 10 l		•																		
	Non-woven Bags 40 l		•																		
	Non-woven Bags 10 l		•																		
	Dirt Bags 30 l		•																		
	Flexible Crevice Nozzle, long		•																		
	Floor Nozzle with Rollers		•																		
	Universal Floor Nozzle		•																		
	Drilling Nozzle		•																		
	Round Carpet Brush		•																		
	Set of Nozzles		•																		
	Car Cleaning Set		•																		
	Premium Suction Hose		•																		
	Suction Hose		•																		
	Suction Hose Extension		•																		
TP-VC 36/30 S Auto	2347143	-	•	•	•	•	-	•	-	•	•	•	•	•	•	•	•	•	•	•	•
TP-VC 18/10 Li Brushless L	2347155	•	-	-	-	-	•	-	•	-	•	•	•	•	•	-	•	•	•	•	•

• Use possible - Use not possible

PROFESSIONAL CORDLESS COMPRESSOR SILENZZO 36/210

PXC battery voltage	2x 18 V
Suction power	210 l/min
Output rate 0 bar 4 bar 7 bar	120 l/min 80 l/min 56 l/min
Tank capacity	8 l
Max. operating pressure	8 bar
Number of cylinders	2
Noise level (LpA)	60 dB (A)
Product weight	18.9 kg (excl. batteries)
Number of batteries / chargers included in the scope of delivery	0 pcs / 0 pcs
Packaging	Colour box
Article number	4020380



2x 18 V

Inflating cycles (6-8 bar) per battery charge

2.0 Ah	2.5 Ah	3.0 Ah	4.0 Ah	5.2 Ah	6.0 Ah	8.0 Ah
18	22	25	36	46	52	72

Stapling (staples: 13 mm) in softwood – max. number per battery charge

350 pcs	450 pcs	600 pcs	720 pcs	850 pcs	1200 pcs	1440 pcs
---------	---------	---------	---------	---------	----------	----------



- Oil-free pump**
low maintenance
service-free
- 36 V battery power**
Twin-Pack technology
- Pressure gauge**
working
pressure up
to 8 bar
- Transport carrying handle**
- Whisper power**
Especially quiet
- Large boiler**
8 L



PROFESSIONAL CORDLESS COMPRESSOR SILENZZO 18/160

PXC battery voltage	18 V
Suction power	160 l/min
Output rate 0 bar 4 bar 7 bar	95 l/min 60 l/min 40 l/min
Tank capacity	6 l
Max. operating pressure	8 bar
Number of cylinders	2
Noise level (LpA)	59 dB (A)
Product weight	16.7 kg (excl. battery)
Number of batteries / chargers included in the scope of delivery	0 pcs / 0 pcs
Packaging	Colour box
Article number	4020385



1x 18 V

Inflating cycles (6-8 bar) per battery charge

2.0 Ah	2.5 Ah	3.0 Ah	4.0 Ah	5.2 Ah	6.0 Ah	8.0 Ah
-	13	16	22	27	32	44

Stapling (staples: 13 mm) in softwood – max. number per battery charge









































-	185 pcs	220 pcs	300 pcs	380 pcs	440 pcs	600 pcs
---	---------	---------	---------	---------	---------	---------



- Oil-free pump**
low maintenance
service-free
- Pressure gauge**
working pressure up to 8 bar
- Whisper power**
Especially quiet
- Transport**
Carrying handle
Sturdy tubular frame
- Large boiler**
6 L



Compressed Air Accessories

Type	Article number	EAN	Properties	Packaging
Fabric Hose	4138210		Length 15 m, Ø internal: 9 mm	Shrink film
Fabric Hose	4138200		Length 15 m, Ø innen: 6 mm	Shrink film
Fabric Hose	4138100		Length 10 m, Ø internal: 6 mm	Shrink film
Spiral Hose	4139430		Length 10 m, Ø internal: 9 mm	Shrink film
Spiral Hose	4139420		Length 8 m, Ø internal: 6 mm	Shrink film
Spiral Hose	4139410		Length 4 m, Ø innen: 6 mm	Shrink film
Inflation Adapters Kit	4139695		8-piece	Colour box
Mini Oiler	4135002		R 1/4" internal thread, R 1/4" external thread	Blister
Filter + Pressure Reducer	4134200		Complete with nipple and quick-lock coupling R 1/4"	Colour box
Filter + Pressure Reducer	4134100		Complete with nipple and quick-lock coupling R 3/8"	Colour box
Combination Conditioning Unit	4135001		Complete with oiler, nipple and quick-lock coupling R 1/4"	Colour box
Combination Conditioning Unit	4135000		Complete with oiler, nipple and quick-lock coupling R 3/8"	Colour box
Special Compressed Air Oil	4138315		500 ml	Plastic bottle
Abrasive Sand	4138311		1 kg, grain size 0.2-0.35 mm	Plastic bottle
Michelin Nipple	4139330		Ø 6 mm	Blister
Quick-lock Coupling	4139206		R 1/4" IT	Blister
Quick-lock Coupling	4139207		R 1/4" ET	Blister
Quick-lock Coupling	4139205		R 3/8" IT	Blister
Quick-lock Coupling	4139208		R 3/8" ET	Blister
Quick-lock Coupling	4139210		R 1/2" internal thread	Blister
Quick-lock Coupling	4139209		R 1/2" external thread	Blister
Quick-lock Coupling	4139301		Ø 6 mm	Blister
Quick-lock Coupling	4139302		Ø 9 mm	Blister
Distributor	4139680		2 quick-lock couplings 3/8" IT	Blister
Threaded grommet	4139665		Ø 6 mm, R 1/4" ET	Blister
Threaded grommet	4139666		Ø 6 mm, R 3/8" ET	Blister
Threaded Nipple	4139655		R 1/4" external thread	Blister
Threaded Nipple	4139650		R 3/8" external thread	Blister
Threaded Nipple	4139640		R 1/4" internal thread	Blister
Threaded Nipple	4139645		R 3/8" internal thread	Blister
Grommet	4139660		Ø 6 mm	Blister
Grommet	4139661		Ø 9 mm	Blister
Double Nipple	4139620		R 1/4" external thread	Blister
Double Nipple	4139610		R 3/8" external thread	Blister
Reduction	4139600		R 3/8" ET to R 1/4" IT	Blister
Reduction	4139605		R 1/2" ET to R 3/8" IT	Blister
Reduction	4139630		R 3/8" ET to R 1/4" ET	Blister
Hose Connection Tube	4139310		Ø 6 mm	Blister
Hose Connection Tube	4139320		Ø 9 mm	Blister
Hose Connector Kit	4139500		Ø 6 mm	Blister
Clip Kit	4139670		5 pcs, 8 - 12 mm	Blister

Compressed Air Staplers/Nailers Accessories

Type	Article number	EAN	Type	Length	Width	Quantity	Suitable for	Packaging
Staples	4137876	4 006825 675467	E, chisel points	38 mm	5.7 mm	3000 pcs	TC-PN 50	Colour box
Staples	4137860	4 006825 504446	E, chisel points	25 mm	5.7 mm	3000 pcs	TC-PN 50	Colour box
Staples	4137875	4 006825 658385	E, chisel points	19 mm	5.7 mm	3000 pcs	TC-PN 50	Colour box
Staples	4137855	4 006825 504439	E, chisel points	16 mm	5.7 mm	3000 pcs	TC-PN 50	Colour box
Staples	4137850	4 006825 504422	E, chisel points	13 mm	5.7 mm	3000 pcs	TC-PN 50	Colour box
Nails	4137873	4 006825 505795	J	50 mm	1.0 mm	3000 pcs	TC-PN 50	Colour box
Nails	4137872	4 006825 504866	J	40 mm	1.0 mm	3000 pcs	TC-PN 50	Colour box
Nails	4137874	4 006825 658378	J	32 mm	1.0 mm	3000 pcs	TC-PN 50	Colour box
Nails	4137871	4 006825 504460	J	25 mm	1.0 mm	3000 pcs	TC-PN 50	Colour box

Assignment of Air Tools to Compressors

		4137790	4132762	4132763	4133210	4133102	4133100	4132759	4133115	4133110	4137000	4139693	4139694	4132741
		TC-PN 50 - Stapler/Nailer	Blow-out Pistol with 4 Nozzles	Blow-out Pistol with 500 mm Nozzle	2-way Blow-out Pistol	Blow-out Pistol, long	Blow-out Pistol, short	Blow-out Pistol Set	Tyre Pressure Gauge, digital	Pro Tyre Pressure Gauge	Tyre Pressure Gauge	Air Tool Set with Bag, 15-piece	Air Tool Set with Bag, 10-piece	Compressed Air Set, 3-piece
SILENZZO 36/210	4020380	•	•	•	•	•	•	•	•	•	•	•	•	•
SILENZZO 18/160	4020385	•	•	•	•	•	•	•	•	•	•	•	•	•

• Use possible - Use not possible

PROFESSIONAL CORDED TOOLS





PROFESSIONAL DEMOLITION HAMMER TP-DH 50

Mains connection	220 - 240 V ~ 50 Hz	
Rated input	1700 W	
Blow rate	1800 min ⁻¹	
Impact force	50 J	
Drill chuck	SDS-hex	
Product weight	18.4 kg	
Additional handle	•	
Accessories	1 pointed chisel, 1 flat chisel	
Packaging	E-Box trolley	
Article number	4139130	 4 006825 630305



Matching accessories

Flat chisel	49191045	 4 009311 910455
Pointed Chisel	49191145	 4 009311 911452



PROFESSIONAL PAINT/MORTAR MIXER TP-MX 1700-2 CE

Mains connection	220 - 240 V ~ 50 Hz	
Rated input	1700 W	
Idle speed	0 - 460 / 0 - 750 min ⁻¹	
Stirrer mount	M14	
Product weight	4.7 kg	
Accessories	1 mortar stirrer (Ø 120 mm)	
Packaging	Colour box	
Article number	4258565	 4 006825 678420



Matching accessories

Mortar Mixer	49497625	 4 009314 976250
Paint Mixer	49497635	 4 009314 976359
Mixer Set, 2-piece	49497695	 4 009314 976953



PROFESSIONAL ROUTER TP-RO 1400 E

NEW

Mains connection	220 - 240 V ~ 50 Hz
Rated input	1400 W
Idle speed	10000 - 30000 min ⁻¹
Stroke height	55 mm
Max. form cutter	30 mm
Product weight	3.5 kg
Parallel stop	•
Compass point	•
Clamp diameter	6 mm / 8 mm
Packaging	Colour box
Article number	4350560



Accessories incl.



Matching accessories

Router Guide Rail Adapter	4350420	
Guide Bar Aluminium 2x 1000 mm	4502118	



PROFESSIONAL ANGLE GRINDER
TP-AG 230/2400

NEW



Mains connection	220 - 240 V ~ 50 Hz	
Rated input	2400 W	
Idle speed	6500 min ⁻¹	
Wheel diameter	230 mm	
Max. cutting depth	71 mm	
Product weight	5.9 kg	
Accessories	Face spanner, cutting wheel guard	
Article number	4430895	 4 006825 685664



PROFESSIONAL ANGLE GRINDER TP-AG 230/2000

NEW

Mains connection	220 - 240 V ~ 50 Hz	
Rated input	2000 W	
Idle speed	6500 min ⁻¹	
Wheel diameter	230 mm	
Max. cutting depth	71 mm	
Product weight	5.9 kg	
Accessories	Face spanner, cutting wheel guard	
Article number	4430896	 4 006825 688788

Matching accessories

TS 230/1 Cutting Stand	4431051	 4 006825 632743
------------------------	---------	---

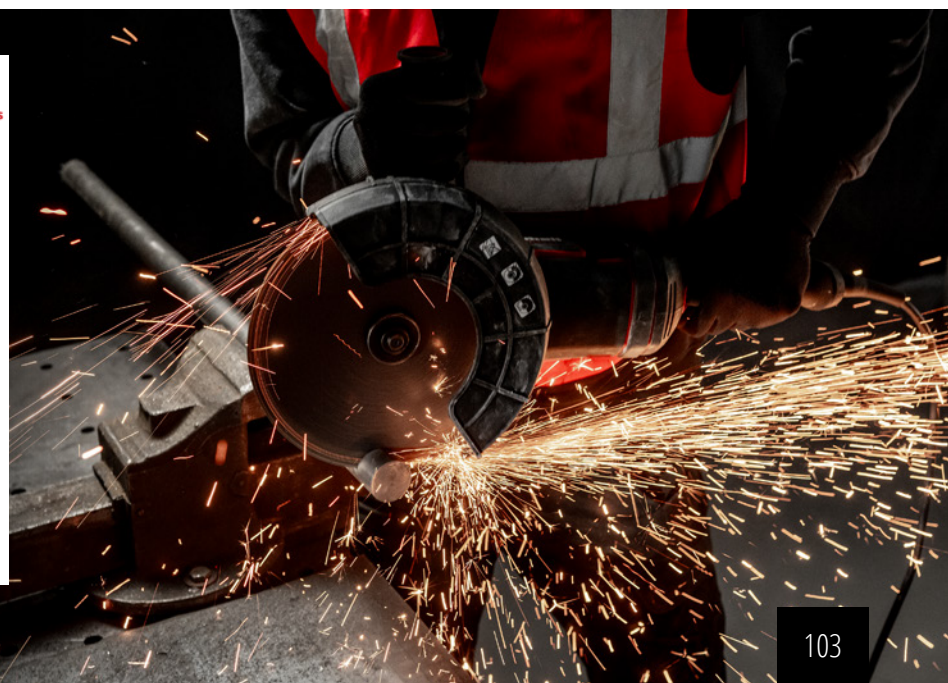



PROFESSIONAL TABLE SAW

TP-CC 10 T







Mains connection	220 - 240 V ~ 50 Hz
Rated input	2000 W S6 25%
Speed	4200 min ⁻¹
Saw blade	Ø 254 x Ø 30 x 2.9 mm
Number of teeth	24
Mitre cut	0° to 45° to the left
Cutting height 90°	85 mm
Cutting height 45°	55 mm
Bench size	630 x 585 mm
Max. cutting capacity on the right	615 mm
Product weight	22.9 kg
Accessories	1x precision saw blade (carbide-tipped), parallel stop (clamped on both sides), angle stop, push stick
Article number	4340435 

Matching accessories

Type	Article number	EAN
 E-Stand TSS	4310605	 4 006825 679472

Matching accessories

TCT saw blade, Ø 254 x Ø 30 x 2.9 mm, t24	4502069	 4 006825 685237
TCT saw blade, Ø 254 x Ø 30 x 2.4 mm, t24	4502073	 4 006825 685244
TCT saw blade, Ø 254 x Ø 30 x 3.2 mm, t48	49589551	 4 009315 895512
TCT saw blade, Ø 254 x Ø 30 x 3.2 mm, t60	49589561	 4 009315 895611



**EINHELL IS
OFFICIAL HOME & GARDEN EXPERT
OF FC BAYERN!**



Einhell

Official Home & Garden Expert



Einhell

PROFESSIONAL



POWER TOOLS 2026